

Detection of new allotypic variants of bovine antibody  
 $\lambda$ -light chain and IgG-heavy chain constant regions

Dissertation

To obtain the Ph.D. degree

In the International Ph. D. Program for Agricultural Sciences in

Goettingen

(IPAG)

At the Faculty of Agricultural Sciences,

Georg-August-University Goettingen, Germany

Presented by

Dalia Mohamed Hemdan Aboelhassan

born in Cairo, Egypt

Göttingen, 2012

D7

Referent: Prof. Dr. Dr. Claus-Peter Czerny

Co-referent: Prof. Dr. Sven König

Date of dissertation: 03.02.2012

# Contents

## Abbreviations

<b>1</b>	<b>INTRODUCTION .....</b>	<b>1</b>
<b>2</b>	<b>REVIEW OF LITERATURE .....</b>	<b>2</b>
2.1	IMMUNOGLOBULIN (IG).....	2
2.2	BOVINE IMMUNOGLOBULINS.....	5
2.3	BOVINE IMMUNOGLOBULIN HEAVY CHAINS.....	6
2.3.1	<i>Bovine immunoglobulin M (IgM)</i> .....	6
2.3.2	<i>Bovine immunoglobulin D (IgD)</i> .....	7
2.3.3	<i>Bovine immunoglobulin E (IgE)</i> .....	8
2.3.4	<i>Bovine immunoglobulin A (IgA)</i> .....	8
2.3.5	<i>Bovine immunoglobulin G (IgG)</i> .....	8
2.4	BOVINE IMMUNOGLOBULIN LIGHT CHAINS.....	12
2.4.1	<i>Bovine <math>\lambda</math> light chains</i> .....	12
2.4.2	<i>Bovine <math>\kappa</math> light chains</i> .....	17
2.5	IMMUNOGLOBULIN ALLOTYPES .....	17
2.6	THE MECHANISMS OF BOVINE IMMUNOGLOBULINS DIVERSITY.....	18
2.6.1	<i>Diversification of heavy chains</i> .....	19
2.6.2	<i>Diversification of light chains</i> .....	20
2.7	CONCEPT OF THE THESIS .....	21
<b>3</b>	<b>MATERIALS AND METHODS .....</b>	<b>22</b>
3.1	BREED SELECTION .....	22
3.2	ISOLATION OF LYMPHOCYTES FROM PERIPHERAL BLOOD.....	22
3.3	COUNTING OF LYMPHOCYTES.....	24
3.4	EXTRACTION OF TOTAL RNA FROM B-LYMPHOCYTES.....	24
3.5	SYNTHESIS OF cDNA.....	25
3.6	PCR AMPLIFICATION OF THE IMMUNOGLOBULIN $\lambda$ -LIGHT CHAIN AND IGG-HEAVY CHAIN REPERTOIRE .....	26
3.7	AGAROSE GEL ELECTROPHORESIS AND PURIFICATION OF PCR PRODUCTS .....	27
3.8	CLONING AND TRANSFORMATION OF PCR PRODUCTS .....	28
3.9	SEQUENCE ANALYSIS OF PCR PRODUCTS.....	30
3.10	HOMOLOGY-BASED MODELING OF THE $\lambda$ -LIGHT CHAIN AND IGG-HEAVY CHAIN CONSTANT REGIONS.....	32
<b>4</b>	<b>RESULTS .....</b>	<b>33</b>
4.1	DETECTION OF NEW ALLOTYPIC VARIANTS OF BOVINE $\lambda$ -LIGHT CHAIN CONSTANT REGIONS AND IGG-HEAVY CHAIN CONSTANT REGIONS.....	33
4.1.1	<i>Detection of new allotypic variants of bovine <math>\lambda</math>-light chain constant regions</i> .....	33
4.1.1.1	Amplification of the transcribed bovine $\lambda$ -light chain repertoire.....	33
4.1.1.2	Allelic variants of IGLC2.....	35

---

4.1.1.2.1	The known allelic variant of IGLC2 (IGLC2 <sup>a</sup> ) .....	35
4.1.1.2.2	The new allelic variant IGLC2 <sup>b</sup> .....	37
4.1.1.2.3	The new allelic variant IGLC2 <sup>c</sup> .....	38
4.1.1.3	Allelic variants of IGLC3 .....	41
4.1.1.3.1	The effect of the changed amino acid residues of IGLC3 allotypes .....	45
4.1.2	<i>Detection of new allotypic variants of bovine IgG-heavy chain constant regions (IGHC)</i> .....	49
4.1.2.1	Amplification of the transcribed bovine IgG-heavy chain repertoire .....	49
4.1.2.2	Polymorphisms of isotype IgG1 within the analyzed breeds .....	51
4.1.2.2.1	Polymorphisms of IgG1 <sup>a</sup> in the analyzed cattle breeds .....	51
4.1.2.2.2	Polymorphisms of IgG1 <sup>b</sup> in the analyzed cattle breeds .....	56
4.1.2.2.3	Polymorphisms of IgG1 <sup>d</sup> in the analyzed cattle breeds .....	58
4.1.2.2.4	The New allele of IgG1 found in German Simmental designated IgG1 <sup>e</sup> .....	61
4.1.2.3	Polymorphism of isotype IgG2 in the analyzed cattle breeds .....	65
4.1.2.3.1	Polymorphisms of IgG2 <sup>a</sup> in the analyzed cattle breeds .....	65
4.1.2.3.2	Polymorphisms of IgG2 <sup>b</sup> in the analyzed cattle breeds .....	68
4.1.2.4	Polymorphisms of IgG3 <sup>b</sup> allotype in the analyzed cattle breeds .....	71
<b>5</b>	<b>DISCUSSION</b> .....	<b>73</b>
<b>6</b>	<b>SUMMARY</b> .....	<b>82</b>
<b>7</b>	<b>BIBLIOGRAPHY</b> .....	<b>84</b>
<b>8</b>	<b>APPENDIX</b> .....	<b>105</b>
<b>9</b>	<b>LIST OF PUBLICATIONS</b> .....	<b>106</b>
<b>10</b>	<b>ACKNOWLEDGMENTS</b> .....	<b>107</b>
<b>11</b>	<b>CURRICULUM VITAE</b> .....	<b>108</b>

## Abbreviations

3D	three-dimensional
A	adenin
A	Aubrac
a.a	Amino acid
Ab	antibody
Acc. No.	accession number
ADCC	antibody-dependent cellular cytotoxicity
AID	activation-induced cytosine deaminase
B-cell	B lymphocytes
bIgG	bovine immunoglobulin G
bIg $\lambda$	bovine immunoglobulin $\lambda$
bp	base pair
BTA	Bos taurus
C	cytosine
C	constant region of immunoglobulin
cDNA	complementary DNA
CDR	complementary determining region
CH	constant region of heavy chain
CL	constant region of light chain
dATP	deoxyadeninetidtriphosphat
DMSO	dimethylsulfoxide
DNA	deoxyribonucleic acid
dNTP	deoxynucleotidtriphosphat
E. coli	Eschericha coli
EcoRI	E. coli restriction enzyme 1
EDTA	ethylenediaminetetraacetic acid
Fab	fragment antigen binding region
Fc	fragment crystallizable
FcR	Fc receptors
FR	framework region
Fv	fragment variable

---

G	guanine
GBP	German Black Pied breed
GS	German Simmental breed
H	heavy chain of immunoglobulin
HF	Holstein Friesian
HV	hypervariable regions
Ig	immunoglobulin
IgBPs	immunoglobulin binding proteins
IGHC	immunoglobulin heavy constant
IGLC	immunoglobulin $\lambda$ -light chain constant region
IPP	ileal Peyer's patches
IPTG	isopropyl- beta- D- Thiogalactopyranosid
$\kappa$	kappa light chain
kb	kilo base pair
L	light chain of immunoglobulin
$\lambda$	lambda light chain
LB	Luria Broth
mAbs	monoclonal antibodies
PBS	phosphate Buffered Saline
PCR	polymerase chain reaction
PDB	program data base
RBC	red blood cell
RFLP	restriction fragment length polymorphism
RNA	ribonucleic Acid
SNP	single nucleotide polymorphism
T	thymine
TAE	tris Acetate EDTA
V	variable region of immunoglobulin
VDJ	variable, diversity, and joining segments
VH	variable region of heavy chain
VL	variable region of light chain
X-gal	5-bromo-4-chloro-3-indolyl-beta-D-galactopyranoside

## Amino acids

A	Alanin
C	Cysteine
D	Aspartic acid
E	Glutamic acid
F	Phenylalanine
G	Glycine
H	Histidine
I	Isoleucine
K	Lysine
L	Leucine
M	Methionine
N	Asparagine
P	Proline
Q	Glutamine
R	Arginine
S	Serine
T	Threonine
V	Valine
W	Tryptophan
Y	Tyrosine

# 1 Introduction

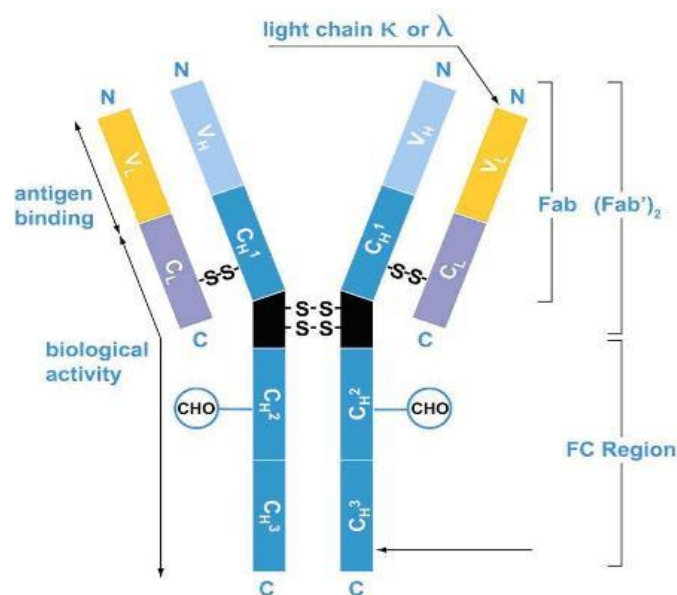
The field of immunogenetics is a genetic approach to immunology, which is vastly growing and has attracted many researchers' attention in the last few decades because of its importance in global or regional eradication or containment of several infectious diseases. There are many studies performed on humans, mice and various other animals. In cattle, immunogenetics still needs more investigation, as we still do not have complete information about the available number of gene segments, gene families of different isotypes of heavy and light chains or their allotypes. These findings could be used in the analysis and creation of recombinant antibodies to replace the use of animals in the creation of antibodies. Recombinant antibodies are considered an advantage of recombinant DNA technology (Jackson *et al.*, 1972) because of the possibility to combine genetic materials from two or more sources. Recombinant antibodies and antibody fragments are important tools for research, diagnostics (Hust *et al.*, 2002) and therapy (Dübel, 2007), in addition to monoclonal antibodies (mAbs) (Hust and Dubel, 2004). Phage display has evolved into a valuable method for the selection of antibody fragments for this purpose (Taussig *et al.*, 2007). Monoclonal antibodies can bind to cell-specific antigens and target those cells for destruction or neutralize any deleterious effects on the body. Therefore mAbs have been considered as an effective therapeutic treatment of many disorders, including inflammatory and putative autoimmune diseases (Hohlfeld and Wekerle, 2005). When a desirable antibody fragment is formed, it can be easily converted into any antibody isotype, for example IgA, IgM, IgG, IgE, and IgD from any species by adding the appropriate constant domain (Moutel *et al.*, 2009). There is variability between the constant regions of different isotypes of heavy and light chains, which cause differences between different breeds of a species. The present work aims to precisely answer these questions, and to confirm that there is variability within the constant regions of heavy and  $\lambda$ -light chains in four cattle breeds which leads to different allotypic variants. This will be proven through carefully designed experiments and comparison between breeds.



## 2 Review of literature

### 2.1 Immunoglobulin (Ig)

An essential component of the vertebrate immune system is the ability to produce a very large number of antibodies (Ab) specificities from a relatively modest number of gene segments (Parng *et al.*, 1996), where it constitutes a major component of humoral immunity (Saini *et al.*, 2007). There are five antibody isotypes or classes which are determined by the type of heavy chain (Rhoades, 2002) known as IgA, IgD, IgE, IgG and IgM (Woof and Burton, 2004). Antibodies are heterodimeric proteins in Y-shaped structure produced by B-cells (Jackson *et al.*, 1992; Litman *et al.*, 1993; Janeway and Travers, 1997) and composed of two heavy (H) and two light (L) chains ( $\lambda$  or  $\kappa$ ). Each H and L chain contains a V (variable) region (VH and VL, respectively), which is solely responsible for antibody affinity and specificity (Torres *et al.*, 2007), and a C (constant) region of H and L chains (CH and CL, respectively) (Fig. 1).



**Fig. 1:** Structure of an IgG molecule showing a simplified schematic representation of the four antibody chains of an IgG antibody, a theoretical model of a human VH and VL, which compose the antigen-binding site of the antibody molecule and CH and CL, The flexible hinge region allows the Y-shaped structure of the molecule (<http://www.abcam.com/index.html?pageconfig=resource&rid=11258&pid=11287>).

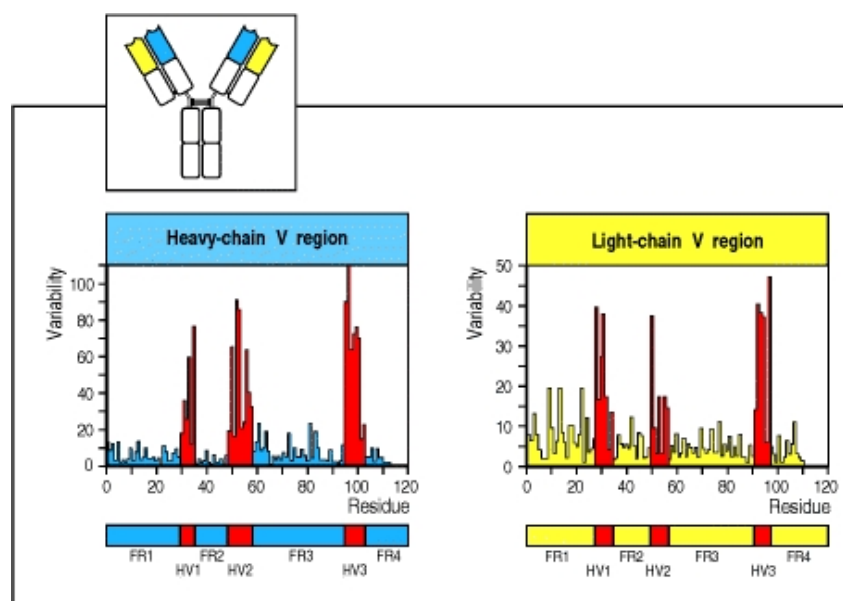
The arms of the Y-shaped structure are formed by the association of a light chain with a heavy chain by pairing of the VH and VL domains and the CH1 and CL domains, which is called Fab (fragment antigen binding) region. The trunk of the Y consists of the carboxy-terminal halves of the two heavy chains. The CH3 domains pair with each other but the CH2 domains do not interact because carbohydrate side chains attached to the CH2 domains lie between the two heavy chains. The two antigen-binding sites are formed by the paired VH and VL domains at the ends of the two arms of the Y and named Fv region (Janeway and Travers, 1997). The different classes of heavy chain differ in size and composition, where  $\alpha$  and  $\gamma$  contain approximately 450 amino acids, while  $\mu$  and  $\epsilon$  have approximately 550 amino acids. The variable region of each heavy chain consists of approximately 110 amino acids long. The light chain is composed of approximately 211 to 217 amino acids (Janeway, 2001).

The differences between the variable domains are located on three loops known as hypervariable regions (HV1, HV2, and HV3) or complementary determining regions (CDR1, CDR2, and CDR3). CDRs are supported within the variable domains by the conserved framework regions (FR1, FR2, FR3, and FR4) (Fig. 2). The heavy chain locus contains about 65 different variable domain genes that all differ in their CDRs. The CDRs of a heavy chain and a light chain units form a surface that is complementary to the surface of the antigen to which they bind in the quaternary structure of the molecule (Jackson *et al.*, 1992). When bound to their antigen, antibodies are able to interact with other molecules of the immune system, such as complement and Fc-receptors (Ravetch and Kinet, 1991) through binding sites that are located on the constant (C) domains of the molecule. The combination of these genes with an array of genes for other domains of the antibody generates a large number of antibodies with a high degree of variability. This combination is called V(D)J recombination (Parham *et al.*, 2005) and is encoded in gene segments. These segments are called variable (V), diversity (D), and joining (J) segments (Nemazee, 2006), which are found in Ig heavy chains, whereas only V and J segments are found in Ig light chains.

In mammal's genome, there are multiple copies of the V, D, and J and different combinations of gene segments. Each developing B cell assemble an immunoglobulin variable region by randomly selecting and combining one V, one

D, and one J gene segment in heavy chain or one V and one J segment in the light chain. This process generates a huge number of antibodies with different antigen specificities (Market and Papavasiliou, 2003). Each B-cell produces antibodies containing only one kind of variable chain in a process called allelic exclusion (Janeway, 2001; Bergman and Cedar, 2004).

The constant region is identical in all antibodies of the same isotype, but differs in antibodies of different isotypes. Heavy chains  $\gamma$ ,  $\alpha$  and  $\delta$  have a constant region composed of three domains (CH1, CH2, and CH3) and a hinge region (sequence intervening between the CH1 and CH2 domains) that are responsible for the biological properties such as complement activation, Fc receptor binding, serum half-life (Ravetch and Kinet, 1991), and for flexibility (Woof and Burton, 2004). Heavy chains  $\mu$  and  $\epsilon$  have a constant region composed of four immunoglobulin domains (CH1, CH2, CH3, and CH4) (Mousavi *et al.*, 1998; Janeway, 2001).



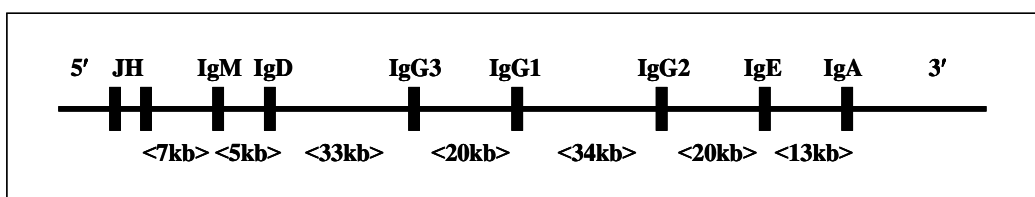
**Fig. 2:** Schematic diagram presents the framework and hypervariable regions of both heavy and light chains, where the blue and yellow colours express the four framework regions of VH and VL domains (FR1, FR2, FR3, and FR4), respectively and the red colour expresses the three hypervariable regions of both VH and VL domains (HV1, HV2, and HV3). The charts are indicated to the high variability of Hypervariable regions comparable with the Framework regions, especially the HV3 (Janeway and Travers, 1997).

## 2.2 Bovine immunoglobulins

Bovines will make a vital contribution to agriculture in both industrial and non-industrial nations in the future and better husbandry practice. The improvement of bovines veterinary healthcare and new agro-industrial opportunities through transgenesis will originate from a deeper understanding of their immunology (Aitken *et al.*, 1999). For these reasons, bovine immunoglobulins (Ig) have attracted more attention last decades especially IgG due to its many effector functions. Colostral immunoglobulins are rich with IgG, where they constitute 85-90% of IgG that provides protection to the neonate (Singh *et al.*, 2011) and it is synthesized locally and released as secretory immunoglobulin on mucosal surfaces (Mestecky *et al.*, 1999).

Bovine immunoglobulins are assembled of heavy and light chains ( $\lambda$  or  $\kappa$ ) like in other species, where their immunoglobulin genes encoding  $\mu$ ,  $\delta$ ,  $\gamma$ ,  $\alpha$ , and  $\epsilon$  have been well described (Knight *et al.*, 1988a; Knight *et al.*, 1988b; Zhao *et al.*, 2002). Three  $\gamma$  genes in the cow (Gu *et al.*, 1992; Zhao *et al.*, 2003) and two in the sheep have been identified (Clarkson *et al.*, 1993), whereas the  $\delta$ ,  $\mu$ ,  $\alpha$ , and  $\epsilon$  genes exist as single copy genes (Mousavi *et al.*, 1998; Zhao *et al.*, 2002). In contrast to human and mice, the number of subclasses of  $\gamma$  and  $\alpha$  varies in both species. The locus in the mouse (JH-  $\mu$ -  $\delta$ -  $\gamma$  3-  $\gamma$  1-  $\gamma$  2<sup>b</sup>-  $\gamma$  2<sup>a</sup>-  $\epsilon$ -  $\alpha$ ) differs from that in the human (JH-  $\mu$ -  $\delta$ -  $\gamma$ 3-  $\gamma$ 1- $\psi\epsilon$ 2-  $\alpha$ 1- $\psi\gamma$ -  $\gamma$ 2-  $\gamma$ 4-  $\epsilon$ 1-  $\alpha$ 2) due to a duplication during evolution of the human (Zhao *et al.*, 2003).

Bacterial artificial chromosomes and cosmid clones have been isolated containing the bovine JH,  $\mu$ ,  $\delta$ ,  $\gamma$ 1,  $\gamma$ 2,  $\gamma$ 3,  $\epsilon$ , and  $\alpha$  genes, which helped make a contig of the genes within the bovine IGHC locus. The arrangement of genes is in a 5'-JH-7 kb- $\mu$ -5 kb- $\delta$ -33 kb- $\gamma$ 3-20 kb- $\gamma$ 1-34 kb- $\gamma$ 2-20 kb- $\epsilon$ -13 kb- $\alpha$ -3' order (Fig. 3), spanning ~150 kb DNA. JH locus examination of bovine germline revealed six JH segments, two of which, JH1 and JH2 were shown to be functional although there was a strong preference for expression of the former (Zhao *et al.*, 2003). The second JH segment undergoes rearrangement at low frequency (Berens *et al.*, 1997). Bovine D locus revealed three genes in 2.3 kb DNA region but it is not known how far they are from bovine JH (Shojaei *et al.*, 2003). Bovine VH locus is little studied, so there is no information about how many VH genes are present (Pallares *et al.*, 1999).



**Fig. 3:** Schematic diagram of the bovine antibody heavy chain (IgHC) locus, indicating the distances (kb) (Zhao *et al.*, 2003).

The comparison of human or murine immunology to bovine showed that the processes which shape the bovine antibodies repertoire can be described as patchy, which may refer to the tendency of cattle IgH chains to carry unusually long CDR3 (Zhao *et al.*, 2006). This property may arise from direct rearrangements of D genes from the germline, where the D-D fusion may share in the generation of long CDR3 (Zhao *et al.*, 2006). Bovine immunoglobulins have been shown to exhibit prophylactic and therapeutic effects in selected infectious diseases in humans and animals by increasing the antibody levels against the disease. In human, bovine milk or colostrum were immunized against *Helicobacter pylori*, which cause gastritis, peptic ulcers and gastric malignancies in humans due to the high amount of IgG in bovine colostrum (Hammarstrom *et al.*, 1994; Weiner *et al.*, 1999; Korhonen *et al.*, 2000; Lilius and Marnila, 2001; Casswall *et al.*, 2002).

## 2.3 Bovine immunoglobulin heavy chains

### 2.3.1 Bovine immunoglobulin M (IgM)

The most important class of immunoglobulin is IgM. It is the major antibody of the primary immune response and it is presented in the sera of all vertebrates due to its large size (Woof and Burton, 2004), where IgM provides the first line of antibody-mediated host defense beside its expression on the newly developing B-lymphocytes (Saini and Kaushik, 2001). IgM is an important bactericidal antibody against mastitis in cattle and other ruminants and combats septicaemia when administered passively to calves (Mousavi *et al.*, 1998). Cow's colostrum and mature milk have appreciable amounts (3 mg/ml) of IgM (Butler, 1995). In bovine, a partial nucleotide sequence of the secreted form of C $\mu$  cDNA

has previously also been determined (Haque, 1992). The IgM gene has four constant region domain encoding exons (CH1, CH2, CH3, and CH4) and two exons encoding the transmembrane domain (TM1, TM2) (Mousavi *et al.*, 1998). There are three bovine IgM allotypes, which designated as IgMa, IgMb and IgMc. These allotypes are classified based on nucleotide substitutions in all the C $\mu$  exons resulting in amino acid replacements. The functional bovine IgM antibodies has especially an exceptionally long CDR3H (up to 61 amino acids) with multiple cysteine residues (Saini *et al.*, 1999), which may provide unknown configuration via inter-CDRHs (possibly by CDR2H and CDR3H) and intra-CDR3H disulfide (Saini and Kaushik, 2001).

### 2.3.2 Bovine immunoglobulin D (IgD)

Immunoglobulin D (IgD) was the least understood immunoglobulin of the five antibody classes found in mammals from a functional and evolutionary perspective (Rogers *et al.*, 2006). Despite IgD is differing in antigen-binding properties from IgM due to their differences in hinge regions (Loiset *et al.*, 2004), the function of IgD is an antigen receptor which is regulated from IgM on the surface of B cells (Loder *et al.*, 1999). Immunoglobulin D is also found in a secreted form with sera concentrations (40  $\mu\text{g/ml}$  in adults) considerably less than those of IgG, IgA and IgM (Preud'homme *et al.*, 2000), which was discovered firstly as a minor component of human serum Igs (Zhao *et al.*, 2002). The cattle, sheep, and pig Ig $\delta$  genes have been identified and shown to be transcriptionally active. The comparison of the deduced amino acid sequences from their cDNAs shows structural similarities to human IgD, where the human, cattle, sheep, and pig IgD heavy chain constant regions have three domains (CH1, CH2, and CH3) and a hinge region. The phylogenetic analysis appeared that C $\delta$  gene was duplicated from the C $\mu$  gene more than 300 million years ago. The CH1 domain of IgD constant regions in cattle and sheep possess an extremely high homology with their respective  $\mu\text{CH1}$  domains unlike humans and rodents. These results indicate that IgD may have some unknown biological properties, which are distinct from those of IgM (Zhao *et al.*, 2002).

### **2.3.3 Bovine immunoglobulin E (IgE)**

IgE is one of the immunoglobulin classes, which were found in a trace amount in the serum. Its additional constant region domain CH4 is responsible for its higher molecular weight than the other Ig classes. The additional domain may be important for binding with high affinity to Fc receptors on mast cells. In bovine genome, the four constant region domains were with a high homology to sheep C $\epsilon$  (87%) and lower to horse (58%) human (55%) and mouse (52%). The main function of IgE-mediated responses is the defense against parasite infections, which is mediated through cells such as basophiles and mast cells. The presence of IgE is considered also as a disadvantage, because it gives rise to type I hypersensitivity reactions such as asthma, conjunctivitis, and rhinitis (Mousavi *et al.*, 1997).

### **2.3.4 Bovine immunoglobulin A (IgA)**

Immunoglobulin A (IgA) is the predominant class of immunoglobulins found on mucosal surfaces, and constitutes an important defense mechanism against microbial infections. In bovine mastitis, the mucosal defense system in the mammary gland plays a major role in the prevention of infection. Hence IgA-binding receptors expressed by bacteria might be involved in the development of mastitis by binding IgA and helping the micro-organism evade the immunological surveillance of the host. The concentration of IgA in colostrum, and in secretions obtained from dry animals increases considerably with respect to the IgA levels in milk (Song *et al.*, 2002). Bovine IgA is a major immunoglobulin in most of all exocrine body fluids in cattle except lacteal body fluid and it is synthesized by the tissues which produce these body fluids. In the late of 1960s, bovine IgA was discovered after many scientists considered that IgG is the predominant immunoglobulin in bovine colostrum and milk. Bovine single C $\alpha$  gene showed at least two allelic variants with highest homology of the deduced amino acids to swine (75%) (Brown *et al.*, 1997).

### **2.3.5 Bovine immunoglobulin G (IgG)**

Immunoglobulin G (IgG) is the most abundant class of antibodies present in blood, lymph, peritoneal fluid, and cerebrospinal fluid, constituting >75% of

serum immunoglobulins (Saini *et al.*, 2007). Surprisingly, some camel IgG2 and IgG3 antibodies exist as homodimers of VH chains, devoid of light chain altogether (Hamers-Casterman *et al.*, 1993).

Three IgG subclasses (IgG1, IgG2, and IgG3) were defined in cattle (Symons *et al.*, 1989; Kacskovics *et al.*, 1995; Kacskovics and Butler, 1996; Rabbani *et al.*, 1997), whereas two subclasses (IgG1 and IgG2) were found in sheep (Clarkson *et al.*, 1993) and seven IgG subclasses (IgG1, IgG2, IgG3, IgG4, IgG5, IgG6, and IgG7) were detected in horse (Wagner *et al.*, 2004). There are two nomenclatures of IgG, the first one used the nomenclature IgG1 for IgG1 subclass, IgG2a for IgG2, and IgG2b for IgG3 based on serological characterization, whereas the second nomenclature which based on molecular characterization using the designation IgG1, IgG2, and IgG3 for the three subclasses (Knight *et al.*, 1988b). The IgG1 and IgG2 are presented at 10 mg/ml in serum and the concentration of IgG1 can exceed 60 mg/ml in hyperimmunized animals. In colostrum, IgG1 concentration can exceed 100 mg/ml, whereas in milk it is present at a level of 10 times of other immunoglobulin classes (Butler, 1995). IgG3 is found in low serum concentration due to its long hinge region than other two isotypes (IgG1 and IgG2), which is a preferred site for proteolysis (Rabbani *et al.*, 1997).

Bovine IgG2 is expressed in two allotypic forms IgG2<sup>a</sup> and IgG2<sup>b</sup> (Kacskovics and Butler, 1996). Additionally, for IgG3 two allotypes have been described (IgG3<sup>a</sup> and IgG3<sup>b</sup>) (Rabbani *et al.*, 1997), whereas IgG1 expressed four allotypes which were designated as IgG1<sup>a</sup> (Kacskovics and Butler, 1996), IgG1<sup>b</sup> (Symons *et al.*, 1989), IgG1<sup>c</sup> (Saini *et al.*, 2007), and IgG1<sup>d</sup> (Jackson *et al.*, 1992). The identification of allotypic variants of IgG provide polymorphic immunoglobulin genetic markers with functional consequences that allotypes can vary in their ability to activate the complement leading to enhanced resistance to bacterial infections (Corbeil *et al.*, 1997). Observations regarding complement activation, age-dependent expression, and influences on the effector function in defending *Haemophilus somnus* and *Tritrichomonas foetus* were found for allotypes of bovine IgG2 (Corbeil *et al.*, 1997; Bastida-Corcuera *et al.*, 1999b; Bastida-Corcuera *et al.*, 2000; Saini *et al.*, 2007).



The three bovine C $\gamma$  genes ( $\gamma$ 1,  $\gamma$ 2, and  $\gamma$ 3) have been mapped to chromosome 21q24 (Gu *et al.*, 1992; Tobin-Janzen and Womack, 1992; Chowdhary *et al.*, 1996) lying between  $\delta$  and  $\epsilon$  genes of the immunoglobulin heavy chain locus spanning approximately 150 kb (Saini *et al.*, 2007). The genes encoding IgG subclasses differ significantly in the hinge region and in the CH3 domain resulting in different biological effector functions. Recent studies have suggested the importance of these effector functions in antibody therapy (Clynes *et al.*, 2000; Cartron *et al.*, 2002; Di Gaetano N, 2003; Kennedy *et al.*, 2004; Natsume *et al.*, 2008). IgG has a wide variety of effector functions such as enhancing of phagocytosis, antibody-dependent cellular cytotoxicity (ADCC), regulation of cytokine and antibody production, antigen processing and presentation, and it is involved in selective transfer via FcRn-like receptor on alveolar epithelial cells of mammary glands (Burg and Pillinger, 2001; Kacs Kovics, 2004; Mestecky, 2005; Pentsuk and van der Laan, 2009). (Kacs Kovics, 2004)(Kacs Kovics, 2004)(Kacs Kovics, 2004)(Kacs Kovics, 2004)Three IgG receptors (Fc $\gamma$ RI (CD64), Fc $\gamma$ RII (CD32), and Fc $\gamma$ RIII (CD16)) have been characterized in humans and mouse, where Fc $\gamma$ RI is a high-affinity receptor found mainly on myelomonocytic cells and bound to monomeric IgG, whereas Fc $\gamma$ RII (CD32) and Fc $\gamma$ RIII (CD16) are lower affinity receptors, which bind primarily aggregated IgG or IgG in immune complexes (Ravetch and Bolland, 2001). The first two distal extracellular domains of Fc $\gamma$ RI function as broadly specific low-affinity receptors, like Fc $\gamma$ RII and Fc $\gamma$ RIII, and it has been suggested that the membrane proximal third domain confers the higher affinity to Fc $\gamma$ RI (Allen and Seed, 1989). Some bovine bacterial pathogens produce immunoglobulin binding proteins (IgBPs) that bind antibodies in a non-immune manner through the Fc region, which may contribute to virulence by interfering with specific binding of antibodies to the pathogen, with complement activation or with phagocytosis (Bastida-Corcuera *et al.*, 1999a). Furthermore a cytolytic cascade is mediated by a series of complement proteins C1 to C9 abundantly present in serum, and triggered by binding of C1q to the Fc region of antibody molecules bound on the cell surface.

The amino acid differences between the known IgG1 allotypes were described in table 1 referring to the position of the amino acid residues changes

using Eu numbering system nomenclature, where the nucleotide sequence comparison of four IgG1 antibody alleles has revealed significant differences in the hinge region spanning codons 216–230. The T224 and T226 of IgG1<sup>a</sup> were replaced with R224 and P226, while both T218 and P224 of IgG1<sup>b</sup> were substituted with R with deletion of S225. Additional amino acid substitutions were noted in the CH1 (positions 190, 192), CH2 (position 281), and CH3 (position 402) domains of IgG1<sup>c</sup>. The three-dimensional models of the heavy chain revealed that all sequence variations were on the surface of the IgG and are possible targets for recognition by antisera and effector molecules such as cellular adhesion molecules. The presence of a repeating motif (PASS: 189–192 and 205–208) in the in CH1 domain of IgG1<sup>c</sup> may stabilize the core immunoglobulin fold or promote interactions with fibronectin or similar adhesion molecules. Replacement of T with R residues within the hinge was predicted to have a dual effect of reducing the number of O-linked glycosylation sites and increasing the susceptibility to degradation by protease secreting bacteria of the hinge region (Saini *et al.*, 2007).

**Table 1:** IgG1<sup>a</sup> (GenBank S82409) (Kacskovics and Butler, 1996); IgG1<sup>b</sup> (GenBank X16701) (Symons *et al.*, 1989); IgG1<sup>c</sup> sequence allele (Clone pTGHC9907; GenBank DQ452014); IgG1<sup>d</sup> refers to cDNA 8.75 clone (GenBank X62916 (Jackson *et al.*, 1992). Indicated is the domain and the position of amino acid according to Eu numbering system and analysis, which were reported by Saini *et al.* (2007).

Domain	CH1		Hinge region				CH2	CH3
Position	190	192	218	224	225	226	281	402
IgG1 <sup>a</sup>	G	T	R	T	-	T	D	G
IgG1 <sup>b</sup>	G	T	T	P	S	P	D	G
IgG1 <sup>c</sup>	A	S	A	R	-	P	N	S
IgG1 <sup>d</sup>	G	T	T	P	S	P	D	S

The research performed by Kacskovics and Butler (1996) for known IgG2 allotypes (IgG2<sup>a</sup> and IgG2<sup>b</sup>) showed that there are many differences in amino acid sequence between them. These amino acid differences are found in the three constant region domains (CH1, CH2, and CH3) and the hinge region. CH1, CH2, and CH3 domains possessed five, three, and seven amino acid residue

substitutions, respectively, where the hinge region showed four amino acid residue differences between the two IgG2 allotypes (Table 2).

**Table 2:** Amino acid differences between two IgG2 allotypes designated as IgG2<sup>a</sup> (GenBank X16702) and IgG2<sup>b</sup> (GenBank S82407). Indicated is the domain and the position of amino acid according to Eu numbering system and analysis, which were performed by (Kacskovics and Butler, 1996)

Domain	CH1					Hinge region				CH2			CH3						
Position	129	131	135	190	192	219	224	225	228	290	326	332	364	370	378	384	402	419	422
IgG2 <sup>a</sup>	S	C	K	G	T	S	P	N	H	T	I	S	V	I	D	D	A	R	T
IgG2 <sup>b</sup>	A	S	T	A	S	I	C	H	P	S	N	P	L	T	A	N	T	E	A

On the other hand, the previous studies indicated that IgG3<sup>b</sup> is more expressed than IgG3<sup>a</sup> (9%), where both allotypes differ in six positions. Three of these amino acid residues are located in the CH1 domain, two in the hinge region, and one in the CH3 domain, which are described in table 3 (Rabbani *et al.*, 1997).

**Table 3:** The amino acid differences between two IgG3 allotypes designated as IgG3<sup>a</sup> (GenBank U63638) and IgG3<sup>b</sup> (GenBank U63639). Indicated is the domain and the position of amino acid according to Eu numbering system and analysis, which were performed by Rabbani *et al.* (1997).

Domain	CH1			Hinge region		CH3
position	131	174	192	237	238	431
IgG3 <sup>a</sup>	S	R	S	P	K	K
IgG3 <sup>b</sup>	R	L	T	Q	E	R

## 2.4 Bovine immunoglobulin light chains

### 2.4.1 Bovine $\lambda$ light chains

Two distinct immunoglobulin light chain isotypes ( $\lambda$  and  $\kappa$ ) have been described in mammals (Pilstrom, 2002; Das *et al.*, 2008). Bovine  $\lambda$ -light chains are expressed in a proportion of 95% (Arun *et al.*, 1996) and the locus was assigned to *Bos taurus* autosome 17 (BTA17) (Tobin-Janzen and Womack, 1992). About 5% of the heavy chains are associated with functional  $\kappa$ -light chains (Arun *et al.*, 1996; Aitken *et al.*, 1999). Their genetic information is located on BTA11 (Ekman *et al.*, 2009). Similarly, horses (Ford *et al.*, 1994) and sheep (Foley and

Beh, 1992; Griebel and Ferrari, 1994; Broad *et al.*, 1995) carry a functional kappa system, but their light chain repertoire is also dominated by  $\lambda$ -light chain expression (Home *et al.*, 1992). In contrast, human expressed 60% of  $\kappa$ -light chains and 95% in mice (Chen *et al.*, 2008).

In cattle, there are at least four immunoglobulin  $\lambda$ -light chain constant region (IGLC) genes (IGLC1, IGLC2, IGLC3, and IGLC4) (Parng *et al.*, 1995, 1996; Chen *et al.*, 2008; Ekman *et al.*, 2009; Pasmán *et al.*, 2010). Two of them (IGLC2 and IGLC3) are functional with preferential expression of IGLC3 during rearrangement while the other two genes (IGLC1 and IGLC4) are pseudogenes (Chen *et al.*, 2008; Ekman *et al.*, 2009; Pasmán *et al.*, 2010) (Fig. 4, 5). In addition, a fifth bovine IGLC gene was detected, which was not yet mapped to a bovine chromosome (Ekman *et al.*, 2009) (Fig. 6). IGLC1 and IGLC2 described by Ekman *et al.* (2009) corresponded to IGLC2 mentioned by Chen *et al.* (2008), as both genes presented the same coding sequences but differ in their 3'UTR. Studies in sheep revealed only two IGLC genes (IGLC1 and IGLC2). The ovine IGLC2 gene presents a premature stop codon (Jenne *et al.*, 2003). In horse DNA, four to seven IGLC genes were identified. Three of these genes are functional, whereas the others seem to be pseudogenes (Home *et al.*, 1992; Das *et al.*, 2008; Sun *et al.*, 2010).

In general, light chains contribute to antigen binding and enlarge variability of the antibodies. The surrogate light chain allows the expression of the heavy-chains in pre-B-cells and therefore is responsible for the expression of B-cell receptors (Meffre *et al.*, 2001). Beside antigen recognition, a structural function of immunoglobulin light chain constant regions is the stabilization of the variable region and the association to the constant region of heavy chain isotypes (Padlan *et al.*, 1986; Chen *et al.*, 2008). Padlan *et al.* (1986) observed specific amino acid residues that formed the inter-domain interface of constant regions of the light chains and the first constant region of the heavy chains in four different Fabs derived from murine and human monoclonal antibodies. Allotypic markers of human light chains were associated with the susceptibility of different infectious diseases (Pandey *et al.*, 1995; Pandey, 2000; Giha *et al.*, 2009). To date there is no description of allotypes in bovine  $\lambda$ -light chain isotypes, which is necessary for the examination of their possible influence in the immune response.

```

G G T C A G C C C A A G T C C C A C C C T C G G T C A C C C T G T T C C C G C Majority
-----+-----+-----+-----+
                      10                20                30                40
-----+-----+-----+-----+
1 . . . . . G . . . . . C1_DQ537487
1 . . . . . C2_DQ537487
1 . . . . . C3_DQ537487
1 . . . . . A . . . . . C4_DQ537487

C C T C C A C G G A G G A G C T C A G C G C C A A C A A G C C A C C C T G G T Majority
-----+-----+-----+-----+
                      50                60                70                80
-----+-----+-----+-----+
41 . . C . . . C . . . . . C1_DQ537487
41 . . . . . A . . . . . C2_DQ537487
41 . . . . . A . . . . . A . G . . . . . C3_DQ537487
41 . . . . . A . . . . . A . . . . . C4_DQ537487

G T G T C T C A T C A G C G A C T T C T A C C C G G G T A G C G T G A C C G T G Majority
-----+-----+-----+-----+
                      90                100               110               120
-----+-----+-----+-----+
81 . . . . . T . . . . . C1_DQ537487
81 . . . . . C2_DQ537487
81 . . . . . C3_DQ537487
81 . . . . . C4_DQ537487

G T C T G G A A G G C A G A C G G C A G C A C C A T C A C C C G C A A C G T G G Majority
-----+-----+-----+-----+
                      130               140               150               160
-----+-----+-----+-----+
121 . C . . . . . C1_DQ537487
121 . C . . . . . A C2_DQ537487
121 . . . . . C3_DQ537487
121 . . . . . A . . . . . A C4_DQ537487

A G A C C A C C C G G G C C T C C A A A C A G A G C A A C A G C A A G T A C G C Majority
-----+-----+-----+-----+
                      170               180               190               200
-----+-----+-----+-----+
161 . . . . . C1_DQ537487
161 . . . . . C2_DQ537487
161 . . . . . C3_DQ537487
161 . . . . . C4_DQ537487

G G C C A G C A G C T A C C T G A G C C T G A C G G G C A G C G A C T G G A A A Majority
-----+-----+-----+-----+
                      210               220               230               240
-----+-----+-----+-----+
201 . . . . . C1_DQ537487
201 . . . . . A . A . . . C2_DQ537487
201 . . . . . A . . . . . C3_DQ537487
201 . . . . . T . . . . . C4_DQ537487

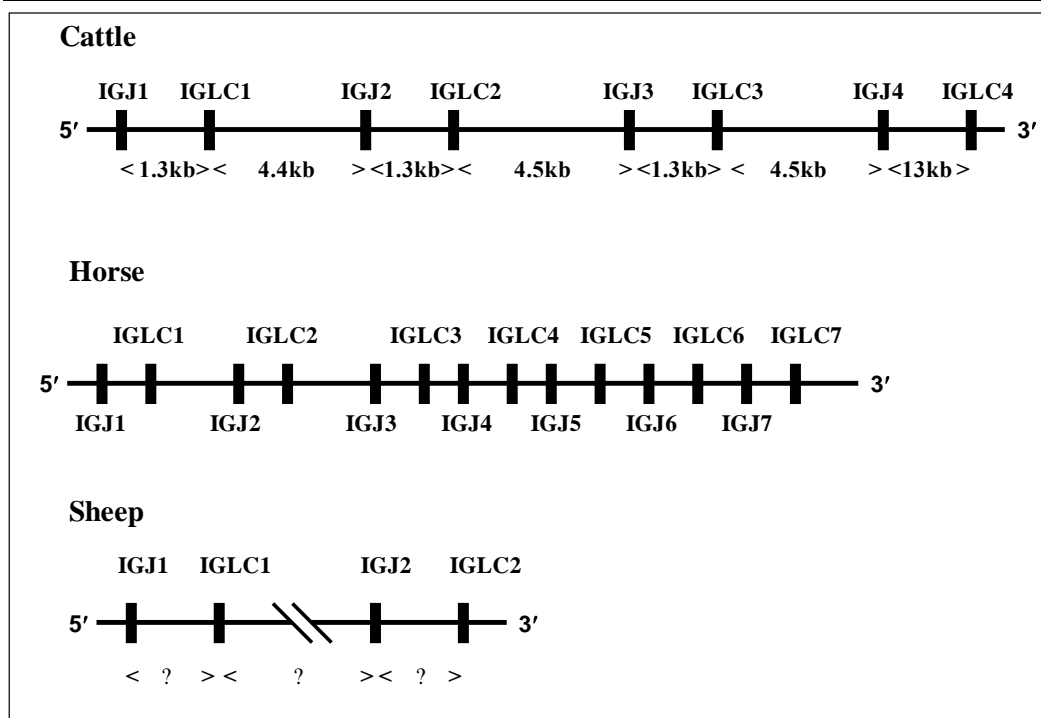
T C G A A A G G C A G T T A C A G C T G C G A G G T C A C G C A C G A G G G G A Majority
-----+-----+-----+-----+
                      250               260               270               280
-----+-----+-----+-----+
240 . . . . . C1_DQ537487
241 . . . . . C2_DQ537487
241 . . . . . C3_DQ537487
241 . . . . . C4_DQ537487

G C A C C G T G A C G A A G A C A G T G A A G A C C T C A G C G T G T T C T T A Majority
-----+-----+-----+-----+
                      290               300               310               320
-----+-----+-----+-----+
280 . . . . . C1_DQ537487
281 . . . . . C2_DQ537487
281 . . . . . C . . . . . A C3_DQ537487
281 . . . . . - . . . . . A C4_DQ537487

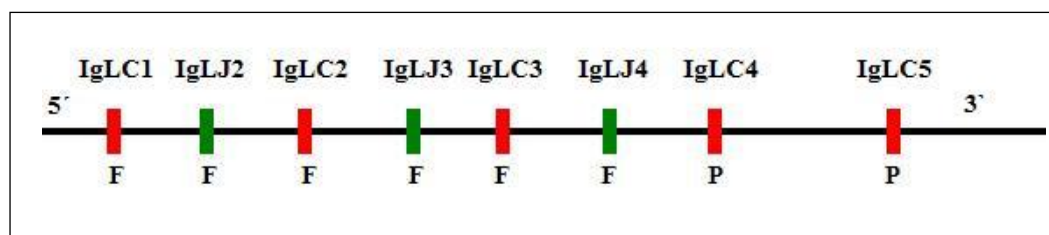
G Majority
--
--
320 . C1_DQ537487
321 . C2_DQ537487
321 . C3_DQ537487
320 . C4_DQ537487

```

**Fig. 4:** Sequences of the four bovine IGLC exons (IGLC1, IGLC2, IGLC3, and IGLC4) according to Chen *et al.* (2008) generated from a BAC library of a Holstein cow showing that IGLC2 and IGLC3 are functional, whereas, IGLC1 and IGLC4 are pseudogenes.



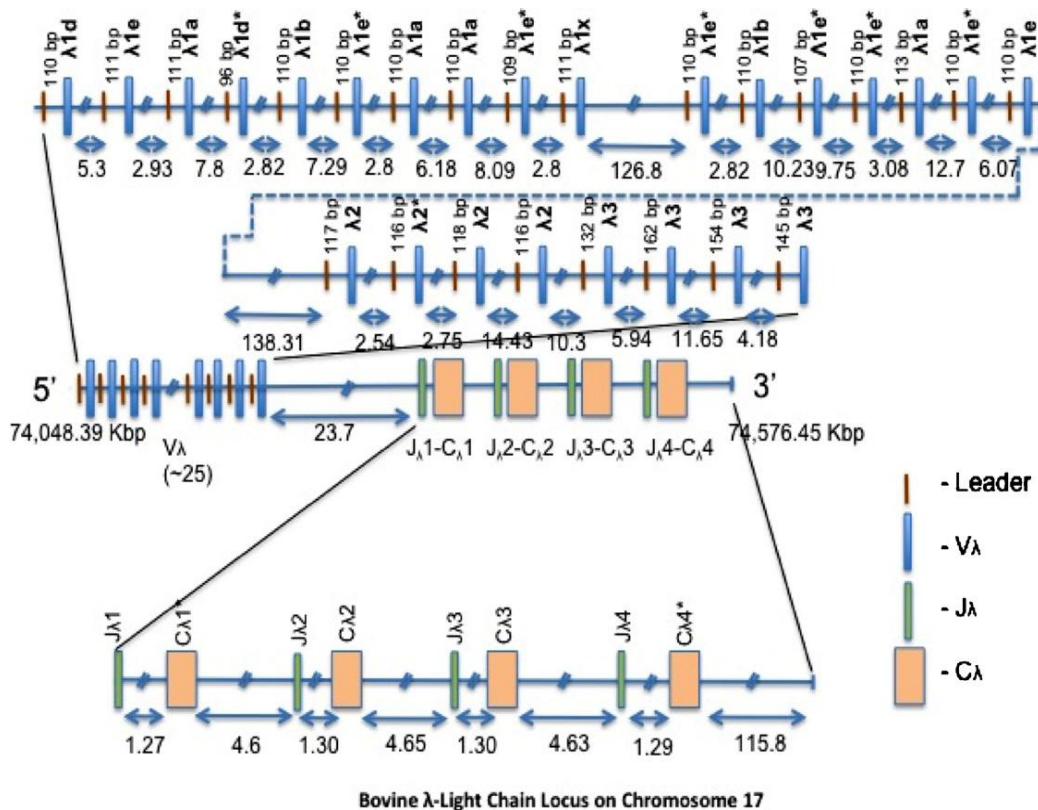
**Fig. 5:** The comparison of the genomic organization of IGLC regions of cattle (Chen *et al.*, 2008) with horse (Home *et al.*, 1992; Sun *et al.*, 2010) and sheep (Jenne *et al.*, 2003).



**Fig. 6:** Schematic representation of bovine IGLJ and IGLC position according to Ekman *et al.* (2009). Functional genes are identified with "F" and pseudogenes with "P". IgLC5 is unplaced.

In cattle, the variable lambda genes ( $V\lambda$ ) were organized into three gene families designated as  $V\lambda 1$ ,  $V\lambda 2$ , and  $V\lambda 3$  (Sinclair *et al.*, 1995; Saini *et al.*, 2003). Based on the genome sequence (Btau\_3.1), 63 variable genes could be identified in ten scaffolds. 25  $V\lambda$  genes are classified as functional genes (Ekman *et al.*, 2009). These genes are grouped into eight families referring to phylogenetic analyses and nucleotide sequence identities in a gene region with correspondence to FR1–FR3, (Reynaud *et al.*, 1991; Reynaud *et al.*, 1995; Reynaud *et al.*, 1997; Hein and Dudler, 1998). The comparison between cattle and ovine gene subgroups revealed that four of six described ovine gene families are represented in the bovine collection, which may be ruminant specific genes. Besides, the restriction of the CDR1 length variation and the number of unique CDR1–CDR2

combinations are lower than in mice and humans (Ekman *et al.*, 2009). The analysis of bovine genome (Btau\_4.0 Herford) that was performed by Pasmán *et al.* (2010) showed that there are 25 V $\lambda$  genes spanning 367.9 kbp 5' to the J $\lambda$ -C $\lambda$  cluster, which were grouped into three V $\lambda$  families (V $\lambda$ 1, V $\lambda$ 2, and V $\lambda$ 3). V $\lambda$ 1 contains 17 genes, ten of them are functional genes whereas seven are pseudogenes. The seventeen V $\lambda$ 1 genes were presented in two sub-clusters that lie 5' to the J $\lambda$ -proximal V $\lambda$  sub-cluster comprising the V $\lambda$ 2 and V $\lambda$ 3 genes. The V $\lambda$ 2 has four genes, three of them are functional gene and the last one is pseudogene. The V $\lambda$ 3 contains four functional genes (Fig. 7). The conserved leader gene sequence led approximately 96–113 bp 5' of V $\lambda$ 1 genes followed by conserved recombination signal sequences (RSS) with a 21–24 bp spacer 3' of each V $\lambda$ 1 gene.



**Fig. 7:** Complete map of bovine  $\lambda$ -light chain locus, spanning 412 kbp, on chromosome 17, modified from J $\lambda$ -C $\lambda$  units (Chen *et al.*, 2008) and Hereford cattle genome (assemble Btau 4.0). Note three sub-clusters of V $\lambda$  genes where most J $\lambda$ -proximal cluster comprises V $\lambda$ 2 and V $\lambda$ 3 genes while 5' two sub-clusters comprise V $\lambda$ 1 genes. Asterisk indicates pseudogene (Pasmán *et al.*, 2010).

### 2.4.2 Bovine $\kappa$ light chains

Cattle express  $\kappa$ -light chains as well as  $\lambda$ -light chains, but similar as with sheep the latter is dominant (Kaushik *et al.*, 2002). Kappa-light chains resample only a small proportion (5%) of the bovine light chain repertoire (Aitken *et al.*, 1999; Saini *et al.*, 2003). In contrast to human and murine  $\kappa$  loci, the bovine  $\kappa$  locus is smaller, more compact, and less complex than the  $\lambda$  locus (Ekman *et al.*, 2009). Differences in  $\kappa$ : $\lambda$  ratio expressed across species might be due to: (a) genomic complexity dependent stochastic expression, (b) recombination signal sequence dependent recombination, (c) ordered rearrangement of  $\kappa$ - and  $\lambda$ -light chain, (d) exogenous antigen selection, or endogenous counter selection (Pasman *et al.*, 2010). Kappa genes are localized in an approximately 280 kb genomic segment, whereas the  $\lambda$  locus encompasses a size of 412 kb (Pasman *et al.*, 2010). The size of the human  $\kappa$  locus is about 1.8 Mb and consists of two contigs, which are located proximally and distally to the J genes. In earlier publications (Weichhold *et al.*, 1993; Zachau, 1993) the presence of 76 V $\kappa$ -segments was described, whereas Kawasaki *et al.* (2001) showed that humans occupy 132 V $\kappa$  genes of which 45 are functional. Functional genes should have open reading frames, cis-acting elements, 8-mer promoters, splicing sites, and recombination signal sequences (RSS). The remaining V $\kappa$ -segments are relicts or truncated pseudogenes. Bovine *in silico* analysis (Ekman *et al.*, 2009) revealed that 22 V $\kappa$ -segments, of which only eight are functional, three J $\kappa$ -segments, and one C $\kappa$ -segment are available. Twenty-one of the 22 V-segments are similar to gene families 1, 2, and 4 of sheep. V $\kappa$ -segments form four subgroups. Seven of the eight functional segments are located in subgroup II.

## 2.5 Immunoglobulin allotypes

Allotypes are antigenic determinants specified by allelic forms of the immunoglobulin genes and polymorphic variants of certain isotypes, which represent amino acid sequence differences of heavy or light chains of different individuals. The immune responses to specific antigens are controlled by the immune response genes, which are major histocompatibility complex (MHC) genes and genes coding for the immunoglobulin (Ig) allotypic markers. These allotypic markers are found in the constant regions of immunoglobulin heavy and



light chains and segregate in a Mendelian manner (Grubb, 1995). The allotypic differences between individual members of a species influenced the immune responsiveness and/or resistance to viral and bacterial infections (Saini *et al.*, 2007). Previous studies have shown associations between Ig allotypic phenotypes and susceptibility to several autoimmune diseases (Kameda *et al.*, 1998).

The influence of allotypes on immune responsiveness may be due to the contribution of particular allotypic determinants to the formation of idiotypes associated with immune responsiveness, or allotypes may contribute to immune responsiveness through their possible influence on antibody affinity (Pandey *et al.*, 2001). In bovine, the immune response of two IgG2 allotypes are different due to the amino acid differences of the constant region of IgG2<sup>a</sup> and IgG2<sup>b</sup> (Kacs Kovics and Butler, 1996; Corbeil *et al.*, 1997). IgG2<sup>b</sup> activate the complement more than twice as compared with IgG2<sup>a</sup>, (Bastida-Corcuera *et al.*, 1999a). *Haemophilus somnus* high molecular weight (HMW) immunoglobulin binding proteins (IgBPs) were bound to IgG2<sup>b</sup> but not IgG2<sup>a</sup>, where the binding of IgG2<sup>b</sup> to *H. somnus* by the Fc portion is associated with resistance of *H. somnus* to killing by the complement (Bastida-Corcuera *et al.*, 1999b; Corbeil, 2002).

## 2.6 The mechanisms of bovine immunoglobulins diversity

Immunoglobulin diversity was documented by six generators, which were the selection of a gene from an initial set of multiple germline genes; rearrangement of these genes; junctional diversity in imprecise gene region joining and non-templated nucleotide addition; variation in heavy and light chain combination; gene conversion; and somatic mutation (Meyer *et al.*, 1997). Previous studies showed that different species developed different ways to ensure an adequate antibody repertoire. Humans and mice use V(D)J-rearrangement and somatic hypermutation. The recombination of V(D)J was mediated by two proteins named the recombination-activating proteins RAG-1 and RAG-2 (Fraenkel *et al.*, 2007). The expression of each B cell or T cell to a single product is subjected to a process of allelic exclusion, which begin early during the development when all of the immune receptor loci become asynchronously replicating, generating a clonally inherited allele-specific mark (Mostoslavsky *et al.*, 2001)

Somatic hypermutation is caused by the introduction of DNA strand breaks in a reaction mediated by activation-induced cytidine deaminase (AID) (Muramatsu *et al.*, 2000), which probably functions as a DNA-editing enzyme (Di Noia and Neuberger, 2002; Petersen-Mahrt *et al.*, 2002; Bransteitter *et al.*, 2003; Chaudhuri *et al.*, 2003). In contrast to humans and mice, other species cannot use these mechanisms because their number of gene segments is too small (Parng *et al.*, 1996; Saini *et al.*, 2003). Cattle apparently possess only few variable gene segments like chicken, sheep, and horses (Parng *et al.*, 1996; Sinclair *et al.*, 1997; Kaushik *et al.*, 2002). For this reason, cattle developed other mechanisms of diversification to ensure an adequate antibody repertoire. The major site of diversification of B cells in cattle is ileal Peyer's patch like sheep, which is responsible for B cell development (Meyer *et al.*, 1997).

### 2.6.1 Diversification of heavy chains

In heavy chains, exceptionally long CDR3 regions cause higher variability (Armour *et al.*, 1994). So far, those long CDR3 regions only have been found in immunoglobulin M (Saini *et al.*, 1999; Saini and Kaushik, 2002; Saini *et al.*, 2003; Kaushik *et al.*, 2009), furthermore, cattle use a single VH-family (Saini *et al.*, 1997; Sinclair *et al.*, 1997). It is also true that there are differences between the somatic mutation in cattle and other species like humans (Tomlinson *et al.*, 1996) or mice (Lopez *et al.*, 1998). It is possible that somatic mutation in cattle happens without a previous antigen contact (Berens *et al.*, 1997). A further study, which related somatic mutation to the diversity of bovine Ig heavy chains, demonstrated that diversity already exists at the foetal stage as a result of somatic mutation. This indicates that the process of somatic mutation seems to be of higher importance in cattle than in humans or mice (Lopez *et al.*, 1998).

In humans and mice, CDR3 region consisted by the combination of VH, DH, and JH that encodes 12 amino acids (Sun *et al.*, 1994; Van Oss and Van Regenmortel, 1994), whereas, in cattle, CDR3 is able to encode up to 27 amino acid residues (Jackson *et al.*, 1996) and up to 30 in chicken (McCormack and Thompson, 1990) due to a tandem usage of DH segments. This indicated that the length of CDR3 region is 50% greater than in human, mice, most swine, and rabbit sequences. It could suggest that the diversification of CDR3 in cattle and

chicken may encode a large number of antibody specificities in comparison with humans and mice (Butler, 1997).

### 2.6.2 Diversification of light chains

Bovine light chain types use gene conversion and somatic hypermutation as major mechanisms for diversification (Parng *et al.*, 1995, 1996), while gene conversion is more important than somatic hypermutation. With regard to this feature cattle and sheep are very similar. It is assumed that somatic mutation is less significant in cattle than in sheep (Parng *et al.*, 1996). This can be attributed to the fact that cattle dispose of a higher number of pseudogenes in V $\lambda$ -segments than sheep (Ekman *et al.*, 2009). Somatic mutation as well as gene conversion needs AID. It depends on the number of available pseudogenes, which are used as donor sequences, if gene conversion or somatic mutation takes place (Arakawa *et al.*, 2004). Ileal Peyer's patches (IPP) from calves of different ages were extracted to compare the sequences of  $\lambda$ -light chains from their follicles; the investigations revealed that the diversity in cattle and sheep appears in the early fetal spleen before the establishment of a diverse repertoire in the ileum (Lee and Richards, 1971). It is possible that this diversity that was found in fetal sequences may have arisen by untemplated somatic point mutations or the contribution of germline variable region functional genes or pseudogenes that have not yet been identified and sequenced (Lucier *et al.*, 1998). Apart from cattle, gene conversion is highly relevant regarding light chain diversification in chicken (Arakawa and Buerstedde, 2009). Rabbits use this mechanism to diversify Ig heavy chains (Weinstein *et al.*, 1994). Another way to improve immune responses is the utilization of allotypes. It is already known that other species like humans and rabbits dispose of light chain allotypes. Depending on the relevance of  $\kappa$ -light chains, humans occupy three Km allotypes called Km 1, Km 1.2, and Km 3 (Moxley and Gibbs, 1992). Rabbits dispose of five allotypes called b4 (a+b), b5, b6, and b9 (Emorine *et al.*, 1983). In cattle only IgG allotypes were detected in the past. The studies undertaken demonstrated a different agency of allotypes IgG2<sup>a</sup> and IgG2<sup>b</sup> (Bastida-Corcuera *et al.*, 1999a; Bastida-Corcuera *et al.*, 1999b). Km allotypes, which are a specification of  $\kappa$ -light chain constant regions, could have a similar effect on humoral immune response and might improve it.

## 2.7 Concept of the thesis

In this research study “Detection of new allotypic variants of bovine antibody  $\lambda$ -light chain and IgG-heavy chain constant regions” we focused on comparative analyses of  $\lambda$ -light and IgG-heavy chain constant region sequences investigation and on the identification of different alleles and allotypic variants, which are based on  $\lambda$ -light chain and IgG-heavy chain constant region sequences available from database entries. Using comparative 3D modeling with known crystal structures, variable allotypic locations of amino acid residue substitutions within the molecule were examined. Their putative influence within the molecule was discussed. We based our analyses of IGLC on the findings of Chen *et al.* (2008) because the complete IGLJ-IGLC cluster from Holstein cattle breed has been sequenced and annotated. We concentrated on the analyses of the conserved constant regions and detection of new alleles and allotypic variants in this research due to their importance in interacting with other molecules of the immune system, such as Fc-receptore and complement through binding sites that are located on Fc of the constant regions of the molecule. Additionally, allelic and allotypic variants have also an influence on the immune responsiveness and resistance to bacterial and viral infections (Saini *et al.*, 2007). Four cattle breeds (German Black Pied, German Simmental, Holstein Friesian, and Aubrac) with different population sizes, distribution areas, and manners of use were examined with regard to the distribution of allotypes.

## 3 Materials and Methods

### 3.1 Breed selection

For the analyses of breed specific expression of immunoglobulin  $\lambda$  and IgG-constant regions, the four cattle breeds German Black Pied (GBP), German Simmental (GS), Holstein-Friesian (HF), and Aubrac (A) were chosen. The selected animals always belonged to one of these four German herds, respectively. Blood samples were collected from ten randomly chosen animals per breed. The herd of the breed Aubrac was composed of seven French and three German animals, whereas the samples of the breed GS included one Austrian bull. Holstein Friesian and GS represent an important global source of commercial milk and meat production, whereas GBP and A influence regional economies.

### 3.2 Isolation of lymphocytes from peripheral blood

#### Material:

Ficoll Paque™ (GE Healthcare, Germany)

Solution A: 0.1% Anhydrous D- Glucose, 5.0 M  $\text{CaCl}_2 \times 2\text{H}_2\text{O}$ , 9.8 M  $\text{MgCl}_2 \times 6\text{H}_2\text{O}$ ,  $5.4 \times 10^{-3}$  M KCl, 0.145 M Tris, pH 7.6  
sterilized by filtration with a 0.22  $\mu\text{m}$  sterile filter

Solution B: 0.14 M NaCl sterilized by filtration with a 0.22  $\mu\text{m}$  sterile filter

Salt solution: Mix one part of solution A to nine parts of solution B

10x PBS: 80 g NaCl, 2 g of KCl, 14.4 g of  $\text{Na}_2\text{PO}_4$ , 2.4  $\text{KH}_2\text{PO}_4$ , d 11 aquadest (sterile)

RBC-buffer (500 ml): 155 mM  $\text{NH}_4\text{Cl}$ , 4.15 g; 10 mM  $\text{NaHCO}_3$ , 0.1 mM EDTA. The pH-value was adjusted with HCl to 7.4 prior to sterilization with a sterile 0.22  $\mu\text{m}$  filter

0.5 M EDTA: 18.6 g of EDTA to 100 ml  $\text{H}_2\text{O}$  at pH 8.0

Fetal calf serum (FCS) Gibco TM Germany DMSO

Freezing Medium: 30% FCS, 60% Medium EMEM or DMEM, 10% DMSO.

Liquid nitrogen

**Equipment:**

Multifuge 3-SR (Kendro, USA)

Centrifuge 5424 (Eppendorf, Germany)

Pipettes (Gilson, USA)

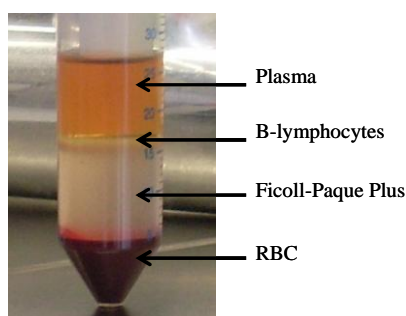
pH-electrode Digital pH-Meter (Knick, USA)

Magnetic stirrer (Elektrotechnik, Germany)

Sterile Tubes (50 ml and 15 ml) (VWR, Germany)

**Method:**

Ten milliliters of peripheral EDTA blood were carefully laid onto 20 ml Ficoll-Paques Plus in a 50 ml sterile reaction tube and centrifuged at room temperature for 400 xg/40 min at 18-20°C for separation of the blood components. Four layers were obtained after centrifugation (Fig. 8). The second layer containing the B-lymphocytes was extracted by using a pipette. The collected cells were resuspended in 1.5 volume of sterile PBS and rinsed by centrifugation at 1200 rpm/15 min at 18-20°C. The pellets of B-lymphocytes were resuspended again in the same volume of sterile PBS and centrifuged again at 1200 rpm/10 min. The washed pellet was resuspended in 10 ml RBC-solution and incubated for 5 min on ice to lyse eventually present red blood cells. PBS was added in 3:1 volume of RBC-solution. A subsequent centrifugation stepped followed at 1200 rpm/10 min at 4°C. Viable B-cells were counted directly on the same day of isolation or mixed with freezing medium and saved in liquid nitrogen.



**Fig. 8:** Lymphocytes at the second layer after separation from blood by centrifugation using Ficoll gradient. The first layer contained plasma, the third layer is Ficoll-Paque, and the fourth layer is red blood corpuscles (RBC).

### 3.3 Counting of lymphocytes

**Material:**

9.5 ml EMEM

500  $\mu$ l of 1% Trypan-blau (1:20)

**Equipment:**

Fuchs-Rosenthal slide

Light microscope Axiovet 40 (Carl Zeiss, Germany)

**Method:**

The stored samples in liquid nitrogen were thawed slowly by moving them with tweezers continuously under warm running water, the number of cells was counted using the Fuchs-Rosenthal-determined counting chamber. To 9.5 ml of EMEM, 500  $\mu$ l trypan-blue and 10  $\mu$ l of cells were mixed on ice. The trypan-blue stains the dead lymphocytes with blue, whereas the living cells remain unstained. The counting chamber was first cleaned and prepared. Then about 20  $\mu$ l of the mixture were placed in the counting chamber and examined under a light microscope. In the counting process, five small squares of a large square (consisting of 16 small squares) from both chambers of the slide were chosen. All viable cells located in the squares, and of the upper or lower, right and left outer line were counted. The blue cells (dead) were neglected. The total number of the cells was calculated as follows:

$n = \text{number of the cells} = \sum i \text{ cells/squares}$

Total number of the cells =  $n * 50$  (Dilution factor) \* 5000 (chamber factor).

### 3.4 Extraction of total RNA from B-lymphocytes

**Material:**

RNeasy<sup>®</sup> Mini Kit (Qiagen, Germany)

Ethanol 70%

Mercaptoethanol (ME)

**Equipment:**

Multifuge 3-SR (Kendro, USA)

Centrifuge 5424 (Eppendorf, Germany)

NanoDrop ND- 1000 Spectrometer (Peqlab, Germany)

**Method:**

Total RNA was isolated from  $1 \times 10^7$  cells by using the RNeasy<sup>®</sup> Mini Kit, as described by the manufacturer. The isolation procedure occurred according to the manufacturing's protocol (Qiagen). Using of RLT buffer (from the kit) allowing the efficient lysis of B-cells, the total RNA was bound to the silica-gel membrane, and undesirable components of the cells were discarded by centrifugation steps, and wash in steps using high-salted buffer systems. The pure total RNA was then eluted from the silica membrane and used for cDNA synthesis. The concentration and purity of the RNA were determined by measuring the absorbance at 260 nm with the NanoDrop.

### 3.5 Synthesis of cDNA

**Material:**

First- Strand cDNA Synthesis Kit (GE Healthcare, UK)

**Equipment:**

Centrifuge 5436 (Eppendorf, Germany)

Thermocycler T3000 (Biometra, Germany)

Incubator CO<sub>2</sub>- AUTO- ZERO (Haeraeus Instruments GmbH, Germany)

**Method:**

The first-strand cDNA was synthesized using pd(N)6-primers from 3 µg of total RNA in a total volume of 20 µl. According to the manufacturer, total RNA was heated at 65°C for 10 min and then chilled on ice directly. Salt solution, DDT, and the primer were added and the mixture was incubated at 37°C for 1 h. The cDNA was stored at -20°C until use.



### 3.6 PCR amplification of the immunoglobulin $\lambda$ -light chain and IgG-heavy chain repertoire

#### Material:

Primer pair of bIg $\lambda$ :

First primer pair of bIg $\lambda$ :

bIg $\lambda$ \_Leader\_1: 5'- ATGGCCTGGTCCCCTCTG-3'

bIg $\lambda$ \_3'UTR: 5'- TCAGGGGTCCATGGAGAG-3'

Second primer pair of bIg $\lambda$ :

bIg $\lambda$ \_Leader\_2: 5'- ATGGCCTTGGCCCCTCTG-3'

bIg $\lambda$ \_3'UTR: 5'- TCAGGGGTCCATGGAGAG-3'

Primer pair of bIgG:

bIgG\_leader: 5'- ATGAACCCACTGTGGACC-3'

bIgG\_3'UTR: 5'- CAGGAGGAATGCACACAG-3'

Aqua dest.

cDNA-Templates

dNTPs (10 pmol ATP, 10 pmol GTP, 10 pmol TTP, 10 pmol CTP),  
(Bioline, Germany)

Taq polymerase (Biotools, Spain)

10 x Buffer with MgCl<sub>2</sub>

#### Equipment:

Thermocycler T3000 (Biometra, Germany)

#### Method:

PCR amplification of  $\lambda$ -light chain was performed using primers annealing within the leader region and 3'UTR of  $\lambda$ -light chains. For the  $\lambda$ -leader region, two different primers were designed on the basis of database sequence information due to polymorphisms in this sequence area referring to accession number BC102189 and BC112657. The annealing site of forward primer bIg $\lambda$ \_Leader\_1 started at position 54 of BC102189, whereas primer bIg $\lambda$ \_Leader\_2 started at position 55 in BC112657. Using the reverse primer bIg $\lambda$ \_3'UTR the expected

product sizes of the  $\lambda$ -light chain including leader, variable, and constant regions are 778bp (BC102189) and 781bp (BC112657).

PCR amplification of IgG heavy chain was performed using primers with binding sites within the leader and 3'UTR regions. Gene specific primers were generated on database sequence information referring to accession number X62916. The annealing site of forward primer bIgG\_leader started at position 22. The expected product size of leader, variable and constant regions was approximately 1.4kb.

A total reaction volume of 50  $\mu$ l contained 0.67  $\mu$ l of cDNA, 200  $\mu$ M dNTPs, 5  $\mu$ l of 10x PCR buffer (75 mM Tris HCl pH 9.0; 2 mM MgCl<sub>2</sub>; 50 mM KCl; 20 mM (NH<sub>4</sub>)<sub>2</sub>SO<sub>4</sub>), 0.4  $\mu$ M of each primer, and 2 units DNA polymerase. PCR was performed under cycling conditions of 95°C for 5 min, followed by 35 cycles of denaturation at 95°C for 1 min, annealing at 59.4°C for 1 min, extension at 72°C for 2 min terminated with elongation at 72°C for 10 min. Length and purity of the PCR products were evaluated by electrophoresis on 1% agarose gels.

### 3.7 Agarose gel electrophoresis and purification of PCR products

#### Material:

Agarose „SeaKem<sup>®</sup>LE“ (Biozym, Germany)

50x TAE- Buffer: 242g Tris, Mwt. 121.14 g/mol (Roth Karlsruhe, Germany)

57.1 ml cold acetic acid (Roth, Germany),

100  $\mu$ l 0.5 M EDTA, pH 8.0

Slandered ladder: 100bp ladder (Life Technologies, Germany)

1kb ladder (Life Technologies, Germany)

Ethidium bromide: 0.5 ng/ml (Roth, Germany)

MiniElute Gel Extraction (Qiagen, Germany)

#### Equipment:

Microwave R- 212 (Sharp Electronics GmbH, Germany)

Fine-scale model 572 (Kern, Germany)

Electrophoresis camera Horizon<sup>®</sup> 58 (Life Technologies, Germany)

Gel tray and comb (C.B.S. Scientific Co., USA)

Current source model PowerPac 300 (BioRad, Germany)

Transilluminator CN-3000 WL Biovision (Vilber Lourmat, Germany)

Centrifuge 5424 (Eppendorf, Germany)

pH-electrode Digital pH-Meter (Knick, USA)

Magnetic stirrer (Elektrotechnik, Germany)

### **Method:**

The length and purity of the PCR products were evaluated by electrophoresis on 1% agarose gels. The gel was prepared by boiling an appropriate amount of agarose (1 g) with 1xTAE buffer (100 ml) and placed in the electrophoresis gel chamber. After the solidification of the gel, the running buffer (1xTAE) was poured over the gel to fill the gel chamber. The appropriate amount of PCR products were mixed with 2 µl of loading buffer. The 1kb and 100bp ladder were loaded in the first and last two lanes, respectively, whereas the PCR products were loaded in the lanes between the ladders. The gel electrophoresis was performed at a constant voltage of 120 V and a current of 400 mA for 60 minutes. The gel was stained for 20 minutes in an ethidium bromide for DNA coloring. The fluorescent dye intercalates only with DNA which was visible on UV light. After the staining step, the gel was photographed under UV light using a gel documentation system according to the base pair ladders and expected PCR product sizes, the correct bands were determined. The PCR-products were purified using the MiniElute Gel Extraction Qiagen kit according to the manufacturer's protocol. QX1 buffer replaced QG buffer. Samples were eluted with 13 µl EB buffer (pH 8.5) and were stored at 4°C.

## **3.8 Cloning and transformation of PCR products**

### **Material:**

dATP (Bioline, Germany)

DNA polymerase (Biotools, Spain)

10 x Buffer with MgCl<sub>2</sub>

**PCR-beads**

pCR<sup>®</sup> 2.1-TOPO<sup>®</sup> 3.9 Kb TA vector (Invitrogen<sup>™</sup>, Germany)

2xTY (Agar plates): 10 g Hefa, 16 g Tryptan (Peptone), 5 g NaCl, 15 g Agar-Agar for solidification, up to 1 liter H<sub>2</sub>O. After autoclaving, addition of 1 ml Ampicilline (Roth, Germany)

LB medium: 20 g of LB medium up to 1 liter H<sub>2</sub>O

X-gal (5-bromo-4-chloro-3-indolyl-beta-D-galactopyranoside): 0.250 g X-gal and 10 ml Formamide

IPTG (Isopropyl β-D-1-thiogalactopyranoside): 5 g IPTG, 21 ml H<sub>2</sub>O

**Equipment:**

Thermocycler T3000 (Biometra, Germany)

Thermomixer 5436 (Eppendorf, Germany)

Water bath GFL 1083 (Gesellschaft für Labortechnik mbH, Germany)

Incubator CO<sub>2</sub>- AUTO- ZERO (Haereus Instruments GmbH, Germany)

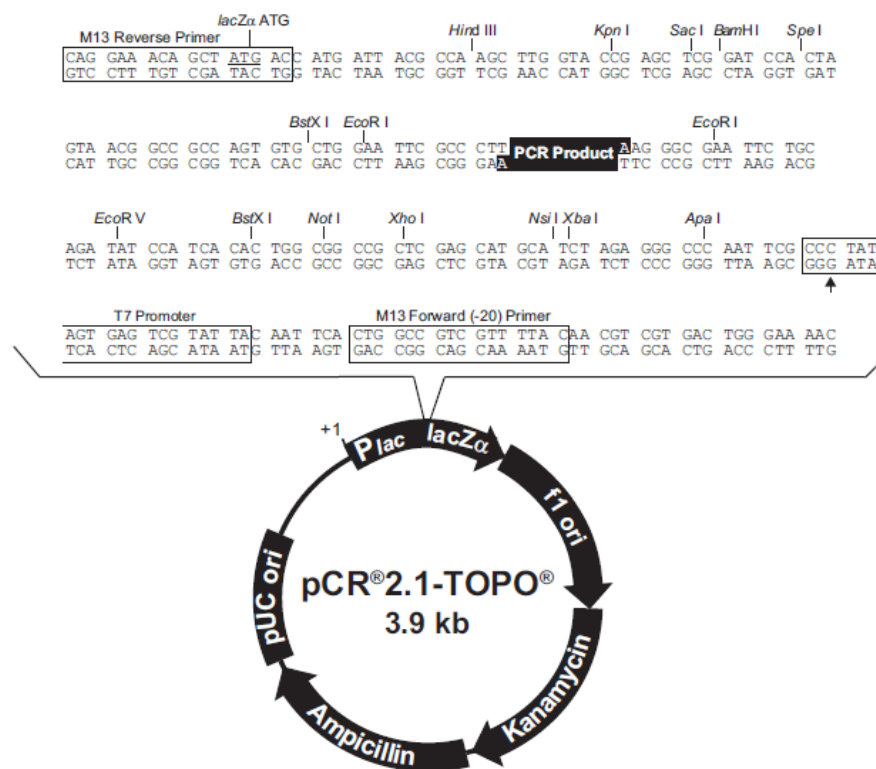
Magnetic stirrer (Elektrotechnik, Germany)

Petri dishes, Bioassay dishes (Nunc, Germany)

**Method:**

Prior to ligation and transformation of purified PCR products, an A-overhang was synthesized using 20 µl purified PCR products, 5 µl dATP, 5 µl 10 x buffer, and 0,4 µl DNA polymerase. DNA products were cloned into the pCR<sup>®</sup> 2.1-TOPO<sup>®</sup> 3.9 kb TA vector and transformed into chemically competent One Shot TOP10 *E. coli* cells (Fig. 9). Transformants were growing overnight at 37°C on LB-agar containing 0.3 mM ampicilline, 40 µl X-gal, and 40 µl 1 M IPTG for blue-white selection. Overnight cultures of randomly chosen white transformants were cultured in 5 ml LB-ampicilline broth. Plasmids were isolated using the MiniPrep Qiagen Kit. In order to assess the insert size, plasmid DNA was either cleaved with *EcoRI* or a colony-PCR was carried out. For this reason a 25 µl mixture containing 2 µl cell culture, 0.4 µM of vector specific primers M13 (-20) Forward and M13 Reverse, and 1 PCR bead were used in a hot start PCR at 95°C for 5 min, denaturation at 95°C for 1 min, annealing at 60°C for 1 min, and

extension at 72°C for 2 min up to a total of 30 cycles. A final extension at 72°C for 10 min was included after the final cycle before PCR mixtures were cooled down to 4°C. The size of the resulting fragments and of the PCR products was confirmed by agarose gel electrophoresis.



**Fig. 9:** The Sequence of the vector, primer binding sites and restriction sites of various restriction enzymes of the vector pCR<sup>®</sup> 2.1 Topo.

### 3.9 Sequence analysis of PCR products

#### Material:

bIg $\lambda$ 1 sequencing primers

bIg $\lambda$ \_Leader\_1: 5'- ATGGCCTGGTCCCCTCTG-3'

bIg $\lambda$ \_3'UTR: 5'- TCAGGGGTCCATGGAGAG-3'

bIg $\lambda$ \_CHrev: 5'- CGTGACCTCGCAGCTGTAAC-3'

bIg $\lambda$ 2 sequencing primers

bIg $\lambda$ \_Leader\_2: 5'- ATGGCCTTGGCCCCTCTG-3'

bIg $\lambda$ \_3'UTR: 5'- TCAGGGGTCCATGGAGAG-3'

bIgλ\_CHrev: 5'- CGTGACCTCGCAGCTGTAAC-3'

bIgG sequencing primers

bIgG\_leader: 5'- ATGAACCCACTGTGGACC-3'

bIgG\_3'UTR: 5'- CAGGAGGAATGCACACAG-3'

bIgG\_CH1for: 5'- GCCTCCACCACAGCCCCGAAAG-3'

bIgG\_CH3rev: 5'- GACCTTGCACTTGA ACTCC-3'

bIgG\_CH: 5'- TGCTGAGCCATCCGTCTT-3'

Vector specific primers M13

M13\_for: 5'- GTAAAACGACGGCCAG-3'

M13\_rev: 5'- CAGGAAACAGCTCTGAC-3'

### Equipment:

ABI Prism<sup>®</sup> 3100 Genetic Analyzer (Applied Biosystems GmbH, Germany.)

DNASar Lasergene v6 (GATC Biotech AG, Germany).

### Method:

Using an ABI Prism 3100 Analyzer, eight clones per animal of IGLC were sequenced. The M13 Forward and M13 Reverse vector specific primers as well as the corresponding gene specific primers bIgλ\_Leader\_1, bIgλ\_Leader\_2, bIgλ\_3'UTR and bIgλ\_CHrev were used for sequencing. The sequences were analyzed with the DNASar program. The framework regions (FR4) and constant regions (IGLC) were aligned with sequences from GenBank by ClustalW (Thompson et al., 1994). The FR4 of joining segments (IGLJ) of the detected constant regions were compared to the known functional joining segments IGLJ2 and IGLJ3 (Chen *et al.*, 2008) in order to determine the corresponding constant regions. The isotypes IGLC2 and IGLC3 were differentiated by their deduced specific C-terminal amino acid residue motifs (TSAC) for IGLC2 and (PSEC) for IGLC3. An allele was defined as new if it was detected in at least two clones sequenced from one animal in order to exclude sequencing errors derived from reverse transcriptase and DNA polymerase amplification.

Sixteen clones per animal of IgG-heavy chain constant regions were sequenced using the same procedure of λ-light chains. The M13 Forward and

M13 Reverse vector specific primers with the gene specific primers bIgG\_leader and bIgG\_Leader\_3'UTR, and additional specific primers for IgG constant region bIgG\_CH1for, bIgG\_CH3rev, bIgG\_CH were used for sequencing. A BLAST search of the NCBI GenBank was performed for IgG-heavy chain constant regions to classify each clone to their known isotypes (IgG1, IgG2, or IgG3). Each isotype was aligned by ClustalW with their respective nucleotide sequences: IgG1 (BC146168, BC147881, S82409\_IgG1<sup>a</sup>, X16701\_IgG1<sup>b</sup>, DQ452014\_IgG1<sup>c</sup>, and X62916\_IgG1<sup>d</sup>), IgG2 (X16702\_IgG2<sup>a</sup>, and S82407\_IgG2<sup>b</sup>), and IgG3 (U63638\_IgG3<sup>a</sup> and U63639\_IgG3<sup>b</sup>).

In an *in silico* analysis, all detected alleles were compared with GenBank entries and bovine ESTs (expressed sequence tags) database (gp/9913.10708/bt\_est; 1559485 sequences) using BLASTN. Breed information derived from those sequences showing 100% coverage and 100% identity to the sequences analyzed were also considered.

### 3.10 Homology-based modeling of the $\lambda$ -light chain and IgG-heavy chain constant regions

#### Equipment:

MacPyMOL software

#### Method:

The deduced amino acid sequences of bovine IGLC2, IGLC3 and IgG1, IgG2, and IgG3 alleles were aligned to known crystal structures of human IgG-heavy and  $\lambda$ -light chains using the PHYRE server (Kelley and Sternberg, 2009). The sequence alignment was used for generating a three-dimensional (3D) model. Graphical analysis and figure preparation were compiled with MacPyMOL. The analysis included the identification of amino acid residue positions performing the connection between the constant region of the heavy chain and light chain according to Padlan *et al.* (1986) and the position of detected amino acid residue substitutions within the 3D-molecule. To demonstrate the accessible surface area, the radii of van der Waals surfaces were calculated with additional 1.4Å (Lee and Richards, 1971).

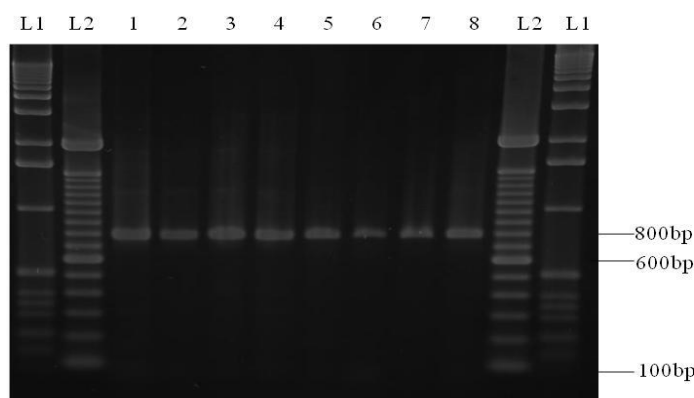
## 4 Results

### 4.1 Detection of new allotypic variants of bovine $\lambda$ -light chain constant regions and IgG-Heavy chain constant regions

#### 4.1.1 Detection of new allotypic variants of bovine $\lambda$ -light chain constant regions

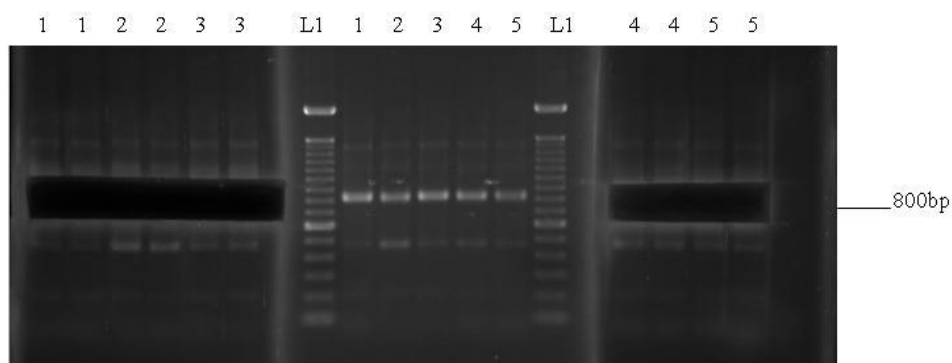
##### 4.1.1.1 Amplification of the transcribed bovine $\lambda$ -light chain repertoire

Lambda light chain repertoire was constructed with B-lymphocytes isolation from ten animals of each breed and pooled to carry out the total RNA extraction. Total RNA was converted into cDNA, which was amplified by PCR using two designed primer sets (bIg $\lambda$ \_Leader\_1/bIg $\lambda$ \_3'UTR and bIg $\lambda$ \_Leader\_2/bIg $\lambda$ \_3'UTR) (Fig. 10). The PCR products of  $\lambda$ -light chains were extracted from the gel and cloned into the vector (Fig. 11). Altogether sixteen white clones per animal (eight clones per animal for each primer set) were chosen from LB-agar plates and plasmid DNA was isolated and cleaved with *EcoRI* (Fig. 12). Plasmid DNA was sequenced using five sequencing primers, bIg $\lambda$ \_Leader\_1, bIg $\lambda$ \_CHrev, bIg $\lambda$ \_3'UTR, M13 Forward, and M13 Reverse vector specific primers for the first primer set and bIg $\lambda$ \_Leader\_2 and bIg $\lambda$ \_CHrev, bIg $\lambda$ \_3'UTR, M13 Forward, and M13 Reverse vector specific primers for the second primer set. After the separation of the constant regions from the variable regions, the constant regions were aligned with the known databases and analyzed using ClustalW.

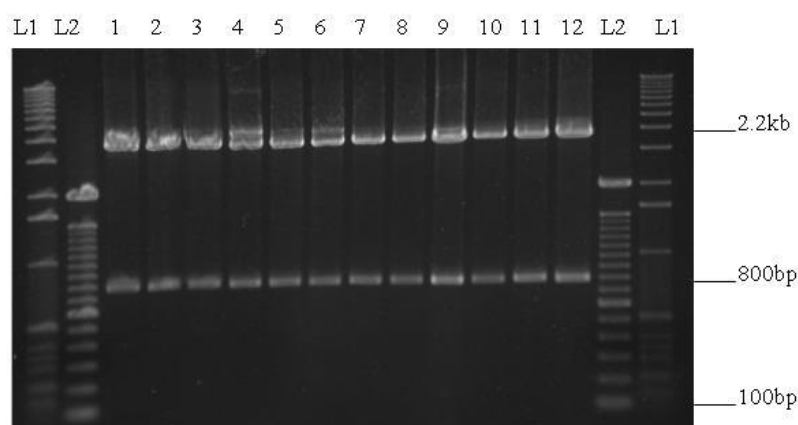


**Fig. 10:** Amplification of  $\lambda$ -light chains with primer pairs Ig $\lambda$ \_leader\_1/Ig $\lambda$ \_3'UTR (1-4) and Ig $\lambda$ \_leader\_2/Ig $\lambda$ \_3'UTR (5-8) and cDNA from four different cattle breeds. 1, 5: German Black Pied, 2, 6: German Simmental, 3, 7: Holstein Friesian, 4, 8: Aubrac, L1: 1kb ladder, L2: 100bp ladder. The expected product sizes were 778bp and 781bp, respectively.





**Fig. 11:** Documentation of the successful gel extraction of the PCR products of *Igλ<sub>leader\_1</sub>/Igλ<sub>3</sub>'UTR* of HF. The amplified PCR products of five animals of HF were load in the middle of the gel as a control and on the outer side of two gel pieces for purification. L1 is the 100bp ladder.



**Fig. 12:** Enzyme cleaved the plasmid DNA of *Igλ<sub>leader\_1</sub>/Igλ<sub>3</sub>'UTR* with the restriction enzyme *EcoRI* to separate the plasmid (at 2.2kb) than DNA product (at 778bp) to prove that the DNA inserts in the correct size. L1: 1kb ladder, L2: 100bp ladder, clones 1-6 for the 2<sup>nd</sup> animal of HF and clones 7-12 for the 3<sup>rd</sup> animal of HF, and 2.2kb is the size of the vector.

The constant regions were aligned to all database entries with their respective FR4 formed by the 3' part of the J-segment to assign them to the corresponding isotype. Most of the analyzed clones belonged to IGLC3, whereas isotype IGLC2 was observed in 4.2% (n=26) of the sequences. This isotype was always represented by 40% of the animals of the breeds German Black Pied (GBP) and Aubrac (A) as well as always by 30% of the animals of the breeds Holstein Friesian (HF) and German Simmental (GS). Single nucleotide polymorphisms (SNPs) were determined and observed for both functional IGLC-genes resulting in silent mutations or amino acid residue substitutions. Single nucleotide polymorphisms and deduced amino acid residue substitutions were

evaluated within the breeds followed by inter-breed comparison. The identified allotypes were compared with bovine ESTs and available breeds were recorded. Consistent with previous studies, C28 and C87 form the intra-chain disulfide bond. Moreover, the inter-chain disulfide to the first constant region of the heavy chain involving C105 was conserved (Chen *et al.*, 2008; Parng *et al.*, 1996).

#### **4.1.1.2 Allelic variants of IGLC2**

##### **4.1.1.2.1 The known allelic variant of IGLC2 (IGLC2<sup>a</sup>)**

The analyses of IGLC were based on the findings of Chen *et al.* (2008), because the complete J<sub>λ</sub>-C<sub>λ</sub> cluster from Holstein cattle breed has been sequenced and annotated, which give the known allele and allotype of IGLC2, designated as IGLC2<sup>a</sup> and represented by all isotype database entries (DQ537487:g. IGLC2-exon 12295...12614) and Btau3.1 NW\_001493546 IGLC1-exone 219204...219523, IGLC2-exon 225462... 225781 (Ekman *et al.*, 2009). However, the genome assembly revealed some differences regarding the J<sub>λ</sub>-C<sub>λ</sub> cluster on BTA17 in Herford genome, where two copies of the C<sub>λ</sub>2 exon exist (Ekman *et al.*, 2009; Paskan *et al.*, 2010). The analyses of GBP and HF revealed the already known allele and allotype IGLC2<sup>a</sup>.

Single nucleotide polymorphisms (SNP) of IGLC2 were detected within the breeds GS and A. The analyses of the obtained sequences revealed two additional alleles, which demonstrated putative new allotypes denominated as IGLC2<sup>b</sup> and IGLC2<sup>c</sup>. Deduced amino acid residue substitutions were referred to the IMGT nomenclature (Lefranc *et al.*, 2005) (Fig. 13). The homology based modeling showed the closest model for all IGLC2 allotypic variants to the crystal structure of human mAb KOL derived Fab (PDB code 2FB4; (Kratzin *et al.*, 1989)). Expect values (E-value) of 1.5e-13 to 4.4e-13 with corresponding identities of 74% to 75% were calculated.

		A																				AB			
		G	Q	P	K	S	P	P	S	V	T	L	F	P	P	S	K	E	E	L	S	AB	AB	AB	
DQ537487_IGLC2	12295	(G)	GT	CAG	CCC	AAG	TCC	CCA	CCC	TCG	GTC	ACC	CTG	TTC	CCG	CCC	TCC	AAG	GAG	GAG	CTC	AGC	---	---	---
IGLC2 <sup>a</sup>	1	.	.	.	.	.	.	.	.	.	.	.	.	.	.	.	.	.	.	.	.	.	---	---	---
IGLC2 <sup>b</sup>	1	.	.	.	.	.	.	.	.	.	.	.	.	.	.	.	.	.	.	.	.	.	---	---	---
IGLC2 <sup>c</sup>	1	.	.	.	.	.	G.	.	.	.	.	.	.	.	.	.	.	.	.	.	.	GA.	---	---	---
NW_001493546_IGLC1	219204	(.)	.	.	.	.	.	.	.	.	.	.	.	.	.	.	.	.	.	.	.	.	---	---	---
NW_001493546_IGLC2	225462	(.)	.	.	.	.	.	.	.	.	.	.	.	.	.	.	.	.	.	.	.	.	---	---	---
DQ537487_IGLC1	6038	(.)	.	.	.	.	G.	.	.	.	.	.	.	.	.	.	C.	.CC	.	.	.	.	---	---	---
DQ537487_IGLC4	24866	(.)	.	.	.	.	A.	.	.	.	.	.	.	.	.	.	.	.	.	.	.	.	---	---	---

		B														BC							
		A	N	K	A	T	L	V	C	L	I	S	D	F	Y	P	G	S	V	T			
DQ537487_IGLC2	12354	GCC	AAC	AAG	GCC	ACC	CTG	GTG	TGT	CTC	ATC	AGC	GAC	TTC	TAC	CCG	---	---	GGT	AGC	GTG	ACC	
IGLC2 <sup>a</sup>	61	.	.	.	.	.	.	.	.	.	.	.	.	.	.	.	---	---	---	---	---	---	
IGLC2 <sup>b</sup>	61	.	.	.	.	.	.	.	.	.	.	.	.	.	.	.	---	---	---	---	---	---	
IGLC2 <sup>c</sup>	61	A.	.	.	.	.	.	.	.	.	.	.	.	.	.	.	---	---	---	---	---	---	
NW_001493546_IGLC1	219263	.	.	.	.	.	.	.	.	.	.	.	.	.	.	.	---	---	---	---	---	---	
NW_001493546_IGLC2	225521	.	.	.	.	.	.	.	.	.	.	.	.	.	.	.	---	---	---	---	---	---	
DQ537487_IGLC1	6098	.	.	.	.	.	.	.	.	.	.	.	.	.	.	.T	---	---	---	---	---	---	
DQ537487_IGLC4	24926	A.	.	.	.	.	.	.	.	.	.	.	.	.	.	.	---	---	---	---	---	---	

		C							CD											
		V	A	W	K	A	D	G	S	T	I	T	R	.1	.2	.3	.4	.5	.6	.7
DQ537487_IGLC2	12411	GTG	GCC	TGG	AAG	GCA	GAC	GCC	AGC	ACC	ATC	ACC	CGC	---	---	---	---	---	---	---
IGLC2 <sup>a</sup>	118	.	.	.	.	.	.	.	.	.	.	.	.	---	---	---	---	---	---	---
IGLC2 <sup>b</sup>	118	.	.	.T.	.	.	.	.	.	.	.	.	.A.	---	---	---	---	---	---	---
IGLC2 <sup>c</sup>	118	.	.	.T.	.	.	.	.	.	.	.	.	.	---	---	---	---	---	---	---
NW_001493546_IGLC1	219320	.	.	.	.	.	.	.	.	.	.	.	.	---	---	---	---	---	---	---
NW_001493546_IGLC2	225578	.	.	.	.	.	.	.	.	.	.	.	.	---	---	---	---	---	---	---
DQ537487_IGLC1	6155	.	.	.	.	.	.	.	.	.	.	.	.	---	---	---	---	---	---	---
DQ537487_IGLC4	24983	.	.	.T.	.A.	.	.	.	.	.	.	.	.A.	---	---	---	---	---	---	---

		D														DE													
		N	V	K	T	T	R	A	S	K	Q	S	N	.1	.2	.3	.4	.5	.6	.7	.7	.6	.5	.4	.3	.2	.1		
DQ537487_IGLC2	12447	AAC	GTG	AAG	ACC	ACC	CGG	GCC	TCC	AAA	CAG	AGC	AAC	---	---	---	---	---	---	---	---	---	---	AGC	AAG	TAC	GCG		
IGLC2 <sup>a</sup>	154	.	.	.	.	.	.	.	.	.	.	.	.	---	---	---	---	---	---	---	---	---	---	---	---	---	---		
IGLC2 <sup>b</sup>	154	.	.	.	G.	.	.	.	.	.	.	.	.	---	---	---	---	---	---	---	---	---	---	---	---	---	---		
IGLC2 <sup>c</sup>	154	G.	.	.	.	.	.	C.	.	.	.	.	.	---	---	---	---	---	---	---	---	---	---	---	---	---	---		
NW_001493546_IGLC1	219356	.	.	.	.	.	.	.	.	.	.	.	.	---	---	---	---	---	---	---	---	---	---	---	---	---	---		
NW_001493546_IGLC2	225614	.	.	.	.	.	.	.	.	.	.	.	.	---	---	---	---	---	---	---	---	---	---	---	---	---	---		
DQ537487_IGLC1	6191	.	.	G.	.	.	.	.	.	.	.	.	.	---	---	---	---	---	---	---	---	---	---	---	---	---	---		
DQ537487_IGLC4	25019	.	.	G.	.	.	.	.	.	.	.	.	.	---	---	---	---	---	---	---	---	---	---	---	---	---	---		

		E														EF	
		A	S	S	Y	L	S	L	T	D	S	D	W	.1	.2		
DQ537487_IGLC2	12495	GCC	AGC	AGC	TAC	CTG	AGC	CTG	ACA	GAC	AGC	GAC	TGG	---	---		
IGLC2 <sup>a</sup>	202	.	.	.	.	.	.	.	.	.	.	.	.	---	---		
IGLC2 <sup>b</sup>	202	.	.	.	.	.	.	.	.	.G	A.	.	.	---	---		
IGLC2 <sup>c</sup>	202	.	.	.	.	.	.	.	.	.	.	.	.	---	---		
NW_001493546_IGLC1	219404	.	.	.	.	.	.	.	.	.	.	.	.	---	---		
NW_001493546_IGLC2	225662	.	.	.	.	.	.	.	.	.	.	.	.	---	---		
DQ537487_IGLC1	6239	.	.	.	.	.	.	.	.	.G	.G.	.	.	---	---		
DQ537487_IGLC4	25067	.	.	.	.	.	.	.	.	.TG	.G.	.	.	---	---		

		F														FG						
		K	S	K	G	S	Y	S	C	E	V	T	H	E	G	S	T	V				
DQ537487_IGLC2	12531	AAA	TCG	AAA	GCC	AGT	TAC	AGC	TGC	GAG	GTC	ACG	CAC	GAG	---	---	---	---	GGG	AGC	ACC	GTG
IGLC2 <sup>a</sup>	238	.	.	.	.	.	.	.	.	.	.	.	.	.	---	---	---	---	---	---	---	---
IGLC2 <sup>b</sup>	238	.	.	.	.	.	.	.	.	.	.	.	.	.	---	---	---	---	---	---	---	---
IGLC2 <sup>c</sup>	238	.	.	.	.	.	.	.	.	.	.	.	.	.	---	---	---	---	---	---	---	---
NW_001493546_IGLC1	219440	.	.	.	.	.	.	.	.	.	.	.	.	.	---	---	---	---	---	---	---	---
NW_001493546_IGLC2	225698	.	.	.	.	.	.	.	.	.	.	.	.	.	---	---	---	---	---	---	---	---
DQ537487_IGLC1	6274	.	.	.	.	.	.	.	.	.	.	.	.	.	---	---	---	---	---	---	---	---
DQ537487_IGLC4	25103	.	.	.	.	.	.	.	.	.	.	.	.	.	---	---	---	---	---	---	---	---

		G										
		T	K	T	V	K	T	S	A	C	S	*
DQ537487_IGLC2	12582	ACG	AAG	ACA	GTG	AAG	ACC	TCA	GCG	TGT	TCT	TAG
IGLC2 <sup>a</sup>	289	.	.	.	.	.	.	.	.	.	.	.
IGLC2 <sup>b</sup>	289	.	.	.	.	.	.	.	.	.	.	.
IGLC2 <sup>c</sup>	289	.	.	.	.	.	.	.	.	.	.	.
NW_001493546_IGLC1	219491	.	.	.	.	.	.	.	.	.	.	.
NW_001493546_IGLC2	225749	.	.	.	.	.	.	.	.	.	.	.
DQ537487_IGLC1	6325	.	.	.	.	.	.	.	.	.	.	.
DQ537487_IGLC4	25154	.	.	.	.	.	.	.A.	.	.	.	.

**Fig. 13:** Isotype IGLC2 (DQ537487\_IGLC2) was aligned by ClustalW (Thompson *et al.*, 1994) using detected allotypes as well as all annotated database information. Sequences were numbered according to the IMGT numbering system for constant domains (Lefranc *et al.*, 2005). A, B, C, D,

E, F, and G correspond to the sandwich fold beta strands, whereas AB, BC, CD, EF, and FG classify the turns and loops. Dots indicate identical nucleotides and dashes indicate gaps. The asterisk marks the stop codon. Amino acid residues that ensure the contact to CH1 within the interface between IGHC1 and IGLC in the crystal structure of human mAb NEW are indicated in bold letters. In the crystal structure of human mAb KOL they are indicated in italic letters (Padlan *et al.*, 1986). Bold and italic letters demonstrate interface residues in both of the mAbs NEW and KOL. Allotype IGLC2<sup>a</sup> was detected in all of the four breeds analyzed, IGLC2<sup>b</sup> was only found in German Simmental and Aubrac. IGLC2<sup>c</sup> was verified in one animal of Aubrac.

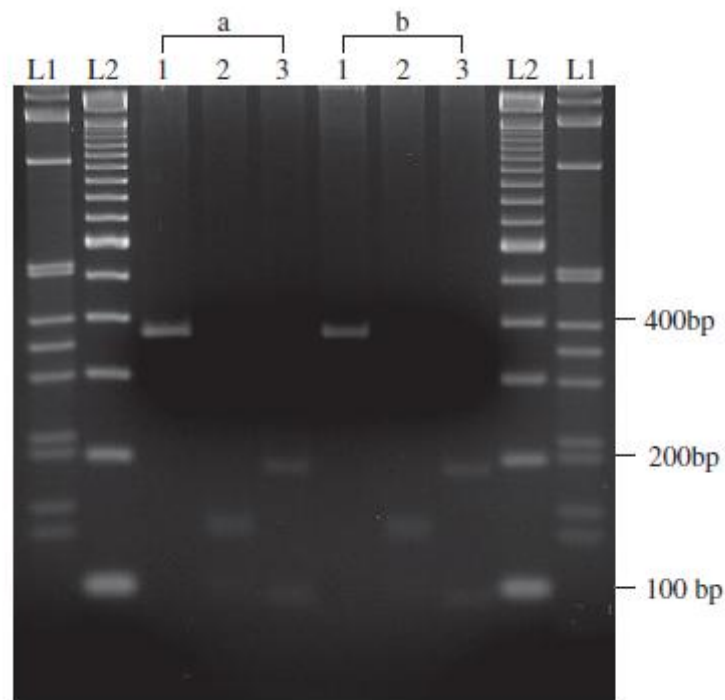
#### 4.1.1.2.2 The new allelic variant IGLC2<sup>b</sup>

Single nucleotide polymorphisms were detected in two animals of GS (HQ456929) and one animal of A (HQ456930) comparing to the positions within the known allele IGLC2<sup>a</sup> of the database entry DQ537487 (Chen *et al.*, 2008) led to a new allotypic variant of IGLC2 designated as IGLC2<sup>b</sup>. These SNPs were found at five positions of IGLC2 sequences, DQ537487:g.12415 C>T describes SNP at nucleotide position 122 of IGLC2, 12445 G>A at position 152, 12453 A>G at position 160, 12518 A>G at position 225, and 12519 G>A at position 226 (Table 4).

Four SNPs led to amino acid residue substitutions within the constant region. The SNPs at position 12415 and 12445 distinguished the allotypic variant IGLC2<sup>b</sup> from IGLC2<sup>a</sup> in two conservative amino acid residue substitutions represented by A40V and R45.5H. Additional substitutions resulted from SNPs 12453 and 12519 leading to charge changes were found at positions 79 and 93. The substitution of D93N in IGLC2<sup>b</sup> resulted in a neutral charge while the replacement of K79E converted the charge into negative. The remaining SNP 12518 caused a silent mutation in T92. Residues 40, 45.5, and 93 were located on the outer side of the molecule in the accessible surface area, whereas position 79 was found in the border area of the putative interface to CH1 as observed by homology based three-dimensional modeling (Fig. 15).

#### 4.1.1.2.3 The new allelic variant IGLC2<sup>c</sup>

IGLC2<sup>c</sup> (HQ456931) was found in only one sequence of Aubrac. In order to verify this allele of the minor expressed isotype IGLC2, we amplified the  $\lambda$ -constant regions from cDNA isolated from this animal using the primers bIg $\lambda$ \_C\_for1 (5'-GCCCTCCAAGGAGGAGCTCGA-3') and bIg $\lambda$ \_3'UTR. After cloning, this sequence was confirmed by RFLP of the *Eco*RI cleaved insert using either *Bbs*I or *Bpu*10I as well as by sequencing RFLP positive plasmids (Fig. 14).



**Fig. 14:** For the confirmation of the newly detected allotype IGLC2<sup>c</sup> an RFLP was performed using *Eco*RI restricted inserts with an overall size of 371bp (1). In case of IGLC2<sup>c</sup>, restriction with *Bbs*I yielded in fragment sizes of 96bp, 132bp, and 143bp (2). One recognition side, which should result in a 9bp and 87bp product, was cleaved. *Bpu*10I was used for a clearer distinction of IGLC2<sup>c</sup>. The second enzyme led to the expected fragment sizes of 89bp, 92bp, and 190bp (3). Both clones (a and b) were sequenced and confirmed the allotypic variant IGLC2<sup>c</sup>. L1: 1kb ladder, L2: 100pb ladder.

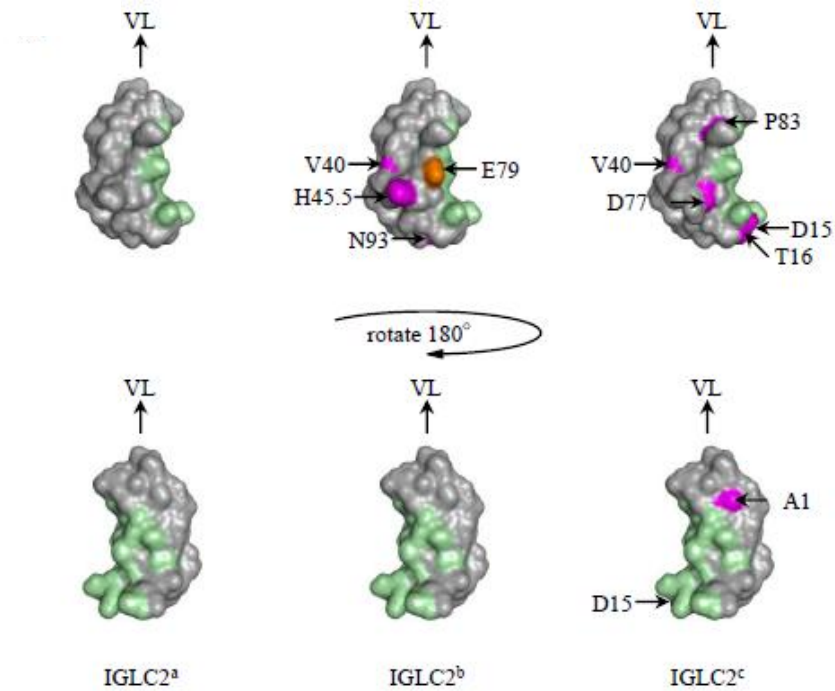
The expected restriction sites of the 371bp insert that belongs to isotype IGLC2 were located at positions 139/141bp, 271/275bp, and 280/284bp for *Bbs*I and at positions 187/190bp and 279/282bp for *Bpu*10I. Sequence analyses possessed seven SNPs in comparing to DQ537487-IGLC2<sup>a</sup>, DQ537487:g.12309 C>G at position 16, 12351 A>G at position 58, 12352 G>A at position 59, 12354 G>A at

position 61, 12415 C>T at position 122, 12447 A>G at position 154, and 12465 G>C at position 172. Three SNPs (12309, 12415, and 12465) affirmed conservative amino acid residue substitutions, respectively, at positions 1, 40, and 83. IGLC2<sup>c</sup> expressed A1, V40, and P83 unlike IGLC2<sup>a</sup>, which showed P1, A40, and A83. A charge change was observed with D77 in IGLC2<sup>c</sup> resulting from SNP 12447. At this position IGLC2<sup>a</sup> presented N77. These four variations occurred in surface exposed residues. Two substitutions were located near to the putative interface; these SNPs (12351 and 12352) led to the replacement of S15 resulting in the negatively charged amino acid residue D. In the following position 12354, the polarity was altered due to A16T replacement as observed by homology based three-dimensional modeling (Table 4, Fig. 15).

**Table 4:** Single nucleotide polymorphisms and their positions according to Acc. No. DQ537487 (Chen *et al.*, 2008) were detected in different alleles of isotypes IGLC2. The positions of the

Allotypic variant of IGLC2	Position of SNP	SNP	Amino acid residue Position	Amino acid residue substitution
IGLC2 <sup>b</sup>	12415	A>T	40	A>V
	12445	G>A	45.5	R>H
	12453	A>G	79	K>E
	12518	A>G	92	T
	12519	G>A	93	D>N
IGLC2 <sup>c</sup>	12309	C>G	1	P>A
	12351	A>G	15	S>D
	12352	G>A		
	12354	G>A	16	A>T
	12415	C>T	40	A>V
	12447	A>G	77	N>D
	12465	G>C	83	A>P

deduced amino acid residues were numbered according to the IMGT numbering system (Lefranc *et al.*, 2005).



**Fig. 15:** Homology based modeling of allotypic variants of IGLC isotypes IGLC2. Solvent accessible surface views are shown for the predicted 3D structures from two opposite sides. The images at the bottom are turned by  $180^\circ$  over the vertical axis compared to those at the top. The putative interface to CH1 derived from the crystal structure of the human mAb NEW and KOL is pale-green. Locations of amino acid residue differences to the basic allotypes IGLC2<sup>a</sup> within the putative interface are marked in orange, whereas the remaining substitutions are marked in magenta. VL indicates the location of the corresponding variable region. The description of the amino acid residues corresponds to the IMGT nomenclature (Lefranc *et al.*, 2005).

The *in silico* analyses were carried out to identify other cattle breeds exhibiting the detected allotypic variants. Besides GBP (HQ456925), GS (HQ456926), HF (HQ456927), and A (HQ456928), IGLC2<sup>a</sup> was found in ESTs of Angus (DY170709), HF (EE967338), and Hereford (EH173018), whereas IGLC2<sup>b</sup> and IGLC2<sup>c</sup> did not have any comparable nucleotide sequences within the ESTs database. The alleles IGLC2<sup>a</sup> and IGLC2<sup>b</sup> were 98.4% identical to each other while IGLC2<sup>c</sup> was 97.8% identical to IGLC2<sup>a</sup> and 96.9% identical to IGLC2<sup>b</sup> (Table 5).

**Table 5:** Percent identity in the upper triangle and divergence in the lower triangle of the detected allotypes of IGLC2 (Chen *et al.*, 2008) were divided by black boxes. Database entries were indicated by their respective accession numbers, calculations were based on pairwise alignment using ClustalW (Thompson *et al.*, 1994). The corresponding allotypes are highlighted in grey and bold. Percent identity was compared to sequence pairs without accounting for their phylogenetic relationships, whereas divergence was calculated in relation to the phylogeny.

	DQ537487 _IGLC2	IGLC2 <sup>a</sup>	IGLC2 <sup>b</sup>	IGLC2 <sup>c</sup>	NW_001493546 _IGLC1	NW_001493546 _IGLC2	DQ537487 _IGLC1	DQ537487 _IGLC4
DQ537487 _IGLC2		100	98.4	97.8	100	100	97.5	96.9
IGLC2 <sup>a</sup>	0		98.4	97.8	100	100	97.5	96.9
IGLC2 <sup>b</sup>	1.6	1.6		96.9	98.4	98.4	97.2	97.8
IGLC2 <sup>c</sup>	2.2	2.2	3.2		97.8	97.8	95.9	96.2
NW_001493546 _IGLC1	0	0	1.6	2.2		100	97.5	96.9
NW_001493546 _IGLC2	0	0	1.6	2.2	0		97.5	96.9
DQ537487 _IGLC1	2.5	2.5	2.9	4.2	2.5	2.5		96.6
DQ537487 _IGLC4	3.2	3.2	2.2	3.9	3.2	3.2	3.5	

#### 4.1.1.3 Allelic variants of IGLC3

The predominantly expressed isotype IGLC3 revealed five allelic variants according to our data from the breeds and GenBank entries. The analyzed sequences were compared with the GenBank entries of IGLC3: DQ537487 (Chen *et al.*, 2008), Btau3.1 NW\_001493546 (Ekman *et al.*, 2009), AF396698 (Parng *et al.*, 1996), BC102189, BC112657, BC114801, BC134589, BC142355, BC142384, BC146272, BC148155, NM\_001083800 (Zimin *et al.*, 2009), X62917 (Jackson *et al.*, 1992).

The constant regions displayed homologies of 96%-100% to each other and were assigned to lambda constant region 3 according to their C terminal amino acid residue motif PSEC (Table 6). Three of the detected alleles were distinguished by GenBank entries and denominated as IGLC3<sup>a</sup> (Accession numbers: DQ537487, NW\_001493546, BC102189, BC114801, BC134589, BC142355, BC142384, BC146272, BC148155, NM\_001083800, and X62917), IGLC3<sup>d</sup> (BC112657), and IGLC3<sup>e</sup> (AF396698). Alignments of the deduced amino acid sequences to the human anti-tetanus Fab  $\lambda$ -light chain (PDB code 1AQK,



(Faber *et al.*, 1998) using the PHYRE server revealed E-values of  $8e-14$  to  $4.6e-13$  with corresponding identities of 75% to 77% for all allotypic variants except IGLC3<sup>b</sup>. This variant displayed an E-value of  $9.13e-13$  and an identity of 74% to the crystal structure of the human mAb KOL (PDB code 2FB4; Kratzin *et al.*, 1989).

In addition to the known allotype IGLC3<sup>a</sup>, two new allotypes (IGLC3<sup>b</sup> and IGLC3<sup>c</sup>) were distributed between the analyzed breeds. Both allotypes possessed equal SNPs at eleven positions of IGLC3 sequences, DQ537487:g.18611 C>G describes SNP at position 16, 18642 C>A at position 47, 18653 A>G at position 58, 18656 G>A at position 61, 18657 G>C at position 62, 18749 A>G at position 154, 18755 G>A at position 160, 18767 G>C at position 172, 18821 A>G at position 226, 18871 G>C at position 276, and 18911 T>C at position 316.

These SNPs resulted in changes in the primary amino acid residues. SNP 18611 switched the codon of P1 into A1, SNP 18642 switched T11 into K11 and N15D resulted from SNP 18653. Amino acids D15/77/109 were caused by SNPs 18653, 18749, and 18871, respectively. Additionally P83/127 that resulted from SNPs 19767 and 18911, respectively, were replaced by A83 and S127.

SNP 18755 changed the codon of E79N. SNP 18821 replaced S93 with D93 of allotype IGLC3<sup>b</sup>, whereas the same amino acid was replaced with G93 in the allotypic variant IGLC3<sup>c</sup>. Both allotypes were distinguished by specific additional changes. IGLC3<sup>b</sup> exhibited two nucleic acid substitutions at DQ537487:g.18820 G>A (SNP 225) leading to silent mutation of T92 and at position 18822 in addition to SNP 18821, which belong to the same amino acid code. On the other hand, allotype IGLC3<sup>c</sup> possessed one different SNP than allotype IGLC3<sup>b</sup> at position DQ537487:g. 18746 C>G (SNP 151), which replaced amino acid R45.5 with G45.5 (Table 7).

Allotypic variant IGLC3<sup>d</sup> represented by GenBank entry BC112657 possessed one SNP at position DQ18871 G>C (SNP 276) resulted amino acid residue transition from E109 to D109. The allotypic variant IGLC3<sup>e</sup> (AF396698) showed one SNP at position DQ18611 C>G (SNP 16) that switched the codon of P1 to A1.



**Table 7:** Single nucleotide polymorphisms and their positions according to Acc. No. DQ537487 (Chen *et al.*, 2008) were detected in different alleles of isotypes IGLC3. The positions of the deduced amino acid residues were numbered according to the IMGT numbering system (Lefranc *et al.*, 2005).

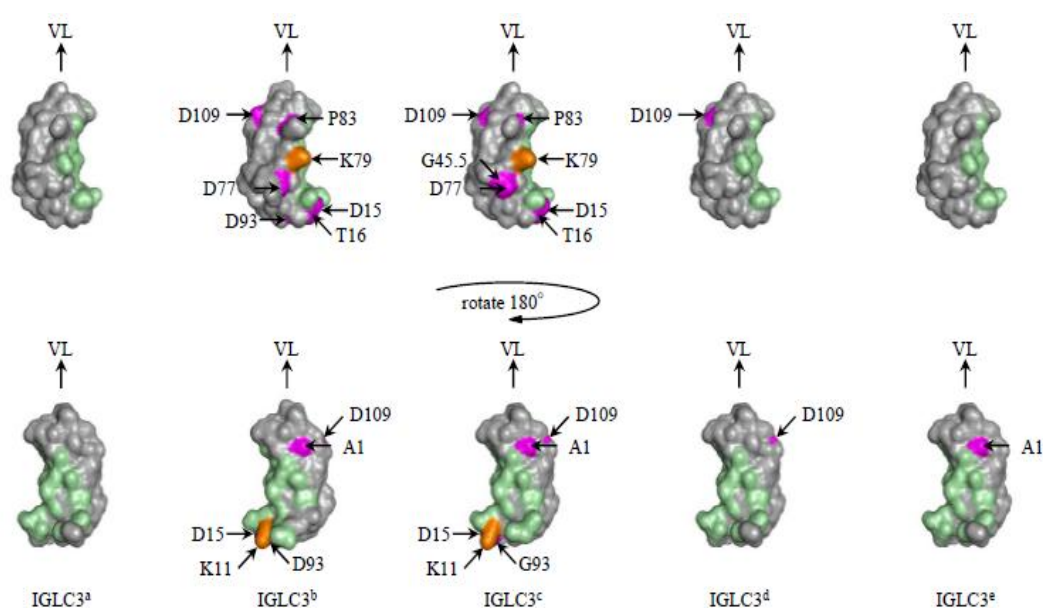
Allotypic variant of IGLC3	Position of SNP	SNP	Amino acid residue Position	Amino acid residue substitution
IGLC3 <sup>b</sup>	18611	C>G	1	P>A
	18642	C>A	11	T>K
	18653	A>G	15	N>D
	18656	G>A	16	G>T
	18657	G>C		
	18749	A>G	77	N>D
	18755	G>A	79	E>N
	18767	G>C	83	A>P
	18820	G>A	92	T
	18821	A>G	93	S>D
	18822	G>A		
	18871	G>C	109	E>D
	18911	T>C	127	S>P
IGLC3 <sup>c</sup>	18611	C>G	1	P>A
	18642	C>A	11	T>K
	18653	A>G	15	N>D
	18656	G>A	16	G>T
	18657	G>C		
	18746	C>G	45.5	R>G
	18749	A>G	77	N>D
	18755	G>A	79	E>N
	18767	G>C	83	A>P
	18821	A>G	93	S>G
	18871	G>C	109	E>D
	18911	T>C	127	S>P
	IGLC3 <sup>d</sup>	18871	G>C	109
IGLC3 <sup>e</sup>	18611	C>G	1	P>A

#### 4.1.1.3.1 The effect of the changed amino acid residues of IGLC3 allotypes

A conservative amino acid residue substitution P1A, which was found in allotypic variants IGLC3<sup>b</sup>, IGLC3<sup>c</sup>, and IGLC3<sup>e</sup> was located near the putative interface to CH1 (Fig. 16, 17). The reverse replacement occurred at position 83 (A83P) of IGLC3<sup>b</sup> and IGLC3<sup>c</sup>. The amino acid residue at this position is located in a small cavity adjoining the putative interface area but seems to be accessible for solvents. Residues 15 and 16 were located between the interfaces formed by the residues at positions 11, 12, 18, and 20. Allotypes IGLC3<sup>a</sup>, IGLC3<sup>d</sup>, and IGLC3<sup>e</sup> represented N15 and G16 as neutral polar and nonpolar residues. In contrast, IGLC3<sup>b</sup> and IGLC3<sup>c</sup> provided the polar and negatively charged D15 as well as the neutral T16. In both variants K11 presented a positively charged amino acid residue. These findings led to a considerable charge shifting on the surface of IGLC3<sup>b</sup> and IGLC3<sup>c</sup>, which was enhanced in IGLC3<sup>b</sup> by an additional S93D replacement. In IGLC3<sup>c</sup> the nonpolar and neutral residue G93 was detected. Amino acid residue position 79 was found in the border area of the putative interface to CH1. A charge change from negative to neutral by E93N substitution was detected in IGLC3<sup>b</sup> and IGLC3<sup>c</sup>. Amino acid residue positions 45.5 and 77 were in direct vicinity to each other as revealed by the 3D-model. Substitutions R45.5G and N77D in IGLC3<sup>c</sup> led to a charge conversion in this molecule part while in IGLC3<sup>b</sup> only the substitution N77D occurred. At the opposite site to the interface to CH1 an E109D substitution was detected in IGLC3<sup>b</sup>, IGLC3<sup>c</sup>, and IGLC3<sup>d</sup> that also lead to charge changes. Only IGLC3<sup>b</sup> and IGLC3<sup>c</sup> had a C-terminal S127P substitution. Two homozygous animals for allele IGLC3<sup>a</sup> were observed in Aubrac (HQ456935). In addition, IGLC3<sup>b</sup> (HQ456939) and IGLC3<sup>c</sup> (HQ456941) were detected in five and three heterozygous animals of this breed, respectively. Eight GBP animals, one GS, and six HF animals were homozygous for the allele IGLC3<sup>a</sup> (HQ456932, HQ456933, HQ456934). Allele IGLC3<sup>b</sup> was found in combination with IGLC3<sup>a</sup> in two animals of the breed GBP (HQ456936), in four animals of the breed GS (HQ456937), and in one HF animal (HQ456938). In animals of the breed GS, the described allele IGLC3<sup>c</sup> (HQ456940) was detected in three heterozygous animals together with IGLC3<sup>a</sup>. Three HF individual animals possessed alleles IGLC3<sup>a</sup> and IGLC3<sup>d</sup> (HQ456943). The allele

IGLC3<sup>d</sup> was also found in one animal of GS (HQ456942), but that time in combination with IGLC3<sup>b</sup>. The allele IGLC3<sup>e</sup> was found in one animal of GS.

*In silico* analyses of the ESTs database revealed nucleotide sequences coding for IGLC3<sup>a</sup> also in Hereford (EV679232), Angus (DY173535), and HF (EE981529), while IGLC3<sup>b</sup> was only found in Angus (DY149783). Allele IGLC3<sup>c</sup> was also found in Holstein Friesian crossbreed (DY145594) and purebred (CK950153). Angus and Holstein Friesian crossbreeds (EV608839, DY216512) as well as Holstein Friesian purebred (CK979405) and Hereford (DT858283) exhibited allele IGLC3<sup>d</sup>.



**Fig. 16:** Homology based modeling of allotypic variants of IGLC isotypes IGLC3. Solvent accessible surface views are shown for the predicted 3D structures from two opposite sides. The images at the bottom are turned by 180° over the vertical axis compared to those at the top. The putative interface to CH1 derived from the crystal structure of the human mAb NEW and KOL is pale-green. Locations of amino acid residue differences to the basic allotypes IGLC3<sup>a</sup>, IGLC3<sup>d</sup>, and IGLC3<sup>e</sup> within the putative interface are marked in orange, whereas the remaining substitutions are marked in magenta. VL indicates the location of the corresponding variable region. The description of the amino acid residues corresponds to the IMGT nomenclature (Lefranc *et al.*, 2005).

		A															AB							
		G	Q	P	K	S	P	P	S	V	T	L	F	P	P	S	T	E	E	L	N	.1	.2	.3
DQ537487_IGLC3	18597	(G)GT	CAG	CCC	AAG	TCC	CCA	CCC	TCG	GTC	ACC	CTG	TTC	CCG	CCC	TCC	ACG	GAG	GAG	CTC	AAC	---	---	---
IGLC3 <sup>a</sup>	1	...	...	...	...	...	...	...	...	...	...	...	...	...	...	...	...	...	...	...	...	---	---	---
IGLC3 <sup>b</sup>	1	...	...	...	...	...	G..	...	...	...	...	...	...	...	...	...	...	A.	...	...	G..	---	---	---
IGLC3 <sup>c</sup>	1	...	...	...	...	...	G..	...	...	...	...	...	...	...	...	...	...	A.	...	...	G..	---	---	---
IGLC3 <sup>d</sup>	1	...	...	...	...	...	...	...	...	...	...	...	...	...	...	...	...	...	...	...	...	---	---	---
AF396698_IGLC3 <sup>a</sup>	388	...	...	...	...	...	G..	...	...	...	...	...	...	...	...	...	...	...	...	...	...	---	---	---
BC102189_IGLC3 <sup>a</sup>	441	...	...	...	...	...	...	...	...	...	...	...	...	...	...	...	...	...	...	...	...	---	---	---
BC112657_IGLC3 <sup>d</sup>	445	...	...	...	...	...	...	...	...	...	...	...	...	...	...	...	...	...	...	...	...	---	---	---
BC114801_IGLC3 <sup>a</sup>	442	...	...	...	...	...	...	...	...	...	...	...	...	...	...	...	...	...	...	...	...	---	---	---
BC134589_IGLC3 <sup>a</sup>	442	...	...	...	...	...	...	...	...	...	...	...	...	...	...	...	...	...	...	...	...	---	---	---
BC142355_IGLC3 <sup>a</sup>	439	...	...	...	...	...	...	...	...	...	...	...	...	...	...	...	...	...	...	...	...	---	---	---
BC142384_IGLC3 <sup>a</sup>	432	...	...	...	...	...	...	...	...	...	...	...	...	...	...	...	...	...	...	...	...	---	---	---
BC146272_IGLC3 <sup>a</sup>	441	...	...	...	...	...	...	...	...	...	...	...	...	...	...	...	...	...	...	...	...	---	---	---
BC148155_IGLC3 <sup>a</sup>	416	...	...	...	...	...	...	...	...	...	...	...	...	...	...	...	...	...	...	...	...	---	---	---
NM_001083800_IGLC3 <sup>a</sup>	442	...	...	...	...	...	...	...	...	...	...	...	...	...	...	...	...	...	...	...	...	---	---	---
NW_001493546_IGLC3 <sup>a</sup>	231771	(.)	...	...	...	...	...	...	...	...	...	...	...	...	...	...	...	...	...	...	...	---	---	---
X62917_IGLC3 <sup>a</sup>	419	...	...	...	...	...	...	...	...	...	...	...	...	...	...	...	...	...	...	...	...	---	---	---
DQ537487_IGLC1	6038	(.)	...	...	...	...	G..	...	...	...	...	...	...	...	...	C..	..C	...	...	...	..G	---	---	---
DQ537487_IGLC4	24866	(.)	...	...	...	...	A..	...	...	...	...	...	...	...	...	...	..A	...	...	...	..G	---	---	---

		B															BC									
		G	N	K	A	T	L	V	C	L	I	S	D	F	Y	P	31	34	35	36	37	38	G	S	V	T
DQ537487_IGLC3	18656	GGC	AAC	AAG	GCC	ACC	CTG	GTG	TGT	CTC	ATC	AGC	GAC	TTC	TAC	CCG	---	---	---	---	---	---	GGT	AGC	GTG	ACC
IGLC3 <sup>a</sup>	61	...	...	...	...	...	...	...	...	...	...	...	...	...	...	...	---	---	---	---	---	---	---	---	---	---
IGLC3 <sup>b</sup>	61	AC.	...	...	...	...	...	...	...	...	...	...	...	...	...	...	---	---	---	---	---	---	---	---	---	---
IGLC3 <sup>c</sup>	61	AC.	...	...	...	...	...	...	...	...	...	...	...	...	...	...	---	---	---	---	---	---	---	---	---	---
IGLC3 <sup>d</sup>	61	...	...	...	...	...	...	...	...	...	...	...	...	...	...	...	---	---	---	---	---	---	---	---	---	---
AF396698_IGLC3 <sup>a</sup>	448	...	...	...	...	...	...	...	...	...	...	...	...	...	...	...	---	---	---	---	---	---	---	---	---	---
BC102189_IGLC3 <sup>a</sup>	501	...	...	...	...	...	...	...	...	...	...	...	...	...	...	...	---	---	---	---	---	---	---	---	---	---
BC112657_IGLC3 <sup>d</sup>	505	...	...	...	...	...	...	...	...	...	...	...	...	...	...	...	---	---	---	---	---	---	---	---	---	---
BC114801_IGLC3 <sup>a</sup>	502	...	...	...	...	...	...	...	...	...	...	...	...	...	...	...	---	---	---	---	---	---	---	---	---	---
BC134589_IGLC3 <sup>a</sup>	502	...	...	...	...	...	...	...	...	...	...	...	...	...	...	...	---	---	---	---	---	---	---	---	---	---
BC142355_IGLC3 <sup>a</sup>	499	...	...	...	...	...	...	...	...	...	...	...	...	...	...	...	---	---	---	---	---	---	---	---	---	---
BC142384_IGLC3 <sup>a</sup>	492	...	...	...	...	...	...	...	...	...	...	...	...	...	...	...	---	---	---	---	---	---	---	---	---	---
BC146272_IGLC3 <sup>a</sup>	501	...	...	...	...	...	...	...	...	...	...	...	...	...	...	...	---	---	---	---	---	---	---	---	---	---
BC148155_IGLC3 <sup>a</sup>	476	...	...	...	...	...	...	...	...	...	...	...	...	...	...	...	---	---	---	---	---	---	---	---	---	---
NM_001083800_IGLC3 <sup>a</sup>	502	...	...	...	...	...	...	...	...	...	...	...	...	...	...	...	---	---	---	---	---	---	---	---	---	---
NW_001493546_IGLC3 <sup>a</sup>	231830	...	...	...	...	...	...	...	...	...	...	...	...	...	...	...	---	---	---	---	---	---	---	---	---	---
X62917_IGLC3 <sup>a</sup>	479	...	...	...	...	...	...	...	...	...	...	...	...	...	...	...	---	---	---	---	---	---	---	---	---	---
DQ537487_IGLC1	6098	.C.	...	...	...	...	...	...	...	...	..T	...	...	...	...	...	---	---	---	---	---	---	---	---	---	---
DQ537487_IGLC4	24926	AC.	...	...	...	...	...	...	...	...	...	...	...	...	...	...	---	---	---	---	---	---	---	---	---	---

		C										CD												
		V	V	W	K	A	D	G	S	T	I	T	R	.6	.7	39	40	41	42	43	44	45		
DQ537487_IGLC3	18713	GTG	GTC	TGG	AAG	GCA	GAC	GGC	AGC	ACC	ATC	ACC	CGC	---	---	---	---	---	---	---	---	---	---	
IGLC3 <sup>a</sup>	118	...	...	...	...	...	...	...	...	...	...	...	...	---	---	---	---	---	---	---	---	---	---	
IGLC3 <sup>b</sup>	118	...	...	...	...	...	...	...	...	...	...	...	...	---	---	---	---	---	---	---	---	---	---	
IGLC3 <sup>c</sup>	118	...	...	...	...	...	...	...	...	...	...	...	G..	---	---	---	---	---	---	---	---	---	---	
IGLC3 <sup>d</sup>	118	...	...	...	...	...	...	...	...	...	...	...	...	---	---	---	---	---	---	---	---	---	---	
AF396698_IGLC3 <sup>a</sup>	505	...	..G	...	...	...	...	...	...	...	...	...	...	---	---	---	---	---	---	---	---	---	---	
BC102189_IGLC3 <sup>a</sup>	558	...	...	...	...	...	...	...	...	...	...	...	...	---	---	---	---	---	---	---	---	---	---	
BC112657_IGLC3 <sup>d</sup>	562	...	...	...	...	...	...	...	...	...	...	...	...	---	---	---	---	---	---	---	---	---	---	
BC114801_IGLC3 <sup>a</sup>	559	...	...	...	...	...	...	...	...	...	...	...	...	---	---	---	---	---	---	---	---	---	---	
BC134589_IGLC3 <sup>a</sup>	559	...	...	...	...	...	...	...	...	...	...	...	...	---	---	---	---	---	---	---	---	---	---	
BC142355_IGLC3 <sup>a</sup>	556	...	...	...	...	...	...	...	...	...	...	...	...	---	---	---	---	---	---	---	---	---	---	
BC142384_IGLC3 <sup>a</sup>	549	...	...	...	...	...	...	...	...	...	...	...	...	---	---	---	---	---	---	---	---	---	---	
BC146272_IGLC3 <sup>a</sup>	558	...	...	...	...	...	...	...	...	...	...	...	...	---	---	---	---	---	---	---	---	---	---	
BC148155_IGLC3 <sup>a</sup>	533	...	...	...	...	...	...	...	...	...	...	...	...	---	---	---	---	---	---	---	---	---	---	
NM_001083800_IGLC3 <sup>a</sup>	559	...	...	...	...	...	...	...	...	...	...	...	...	---	---	---	---	---	---	---	---	---	---	
NW_001493546_IGLC3 <sup>a</sup>	231887	...	...	...	...	...	...	...	...	...	...	...	...	---	---	---	---	---	---	---	---	---	---	
X62917_IGLC3 <sup>a</sup>	536	...	...	...	...	...	...	...	...	...	...	...	...	---	---	---	---	---	---	---	---	---	---	
DQ537487_IGLC1	6155	...	..C.	...	...	...	...	...	...	...	...	...	...	---	---	---	---	---	---	---	---	---	---	
DQ537487_IGLC4	24983	...	...	..A.	...	...	...	...	...	...	...	...	...	..A.	---	---	---	---	---	---	---	---	---	---

		D															DE										
		N	V	E	T	T	R	A	S	K	Q	S	N	.1	.2	.3	.4	.5	.6	.7	.7	.6	.5	.4	.3	.2	.1
DQ537487_IGLC3	18749	AAC	GTG	GAG	ACC	ACC	CGG	GCC	TCC	AAA	CAG	AGC	AAC	---	---	---	---	---	---	---	---	---	---	---	---	---	---
IGLC3 <sup>a</sup>	154	...	...	...	...	...	...	...	...	...	...	...	...	---	---	---	---	---	---	---	---	---	---	---	---	---	---
IGLC3 <sup>b</sup>	154	G..	...	..A.	...	...	...	C..	...	...	...	...	...	---	---	---	---	---	---	---	---	---	---	---	---	---	---
IGLC3 <sup>c</sup>	154	G..	...	..A.	...	...	...	C..	...	...	...	...	...	---	---	---	---	---	---	---	---	---	---	---	---	---	---
IGLC3 <sup>d</sup>	154	...	...	...	...	...	...	...	...	...	...	...	...	---	---	---	---	---	---	---	---	---	---	---	---	---	---
AF396698_IGLC3 <sup>a</sup>	541	...	...	...	...	...	...	...	...	...	...	...	...	---	---	---	---	---	---	---	---	---	---	---	---	---	---
BC102189_IGLC3 <sup>a</sup>	594	...	...	...	...	...	...	...	...	...	...	...	...	---	---	---	---	---	---	---	---	---	---	---	---	---	---
BC112657_IGLC3 <sup>d</sup>	598	...	...	...	...	...	...	...	...	...	...	...	...	---	---	---	---	---	---	---	---	---	---	---	---	---	---
BC114801_IGLC3 <sup>a</sup>	595	...	...	...	...	...	...	...	...	...	...	...	...	---	---	---	---	---	---	---	---	---	---	---	---	---	---
BC134589_IGLC3 <sup>a</sup>	595	...	...	...	...	...	...	...	...	...	...	...	...	---	---	---	---	---	---	---	---	---	---	---	---	---	---
BC142355_IGLC3 <sup>a</sup>	592	...	...	...	...	...	...	...	...	...	...	...	...	---	---	---	---	---	---	---	---	---	---	---	---	---	---
BC142384_IGLC3 <sup>a</sup>	585	...	...	...	...	...	...	...	...	...	...	...	...	---	---	---	---	---	---	---	---	---	---	---	---	---	---
BC146272_IGLC3 <sup>a</sup>	594	...	...	...	...	...	...	...	...	...	...	...	...	---	---	---	---	---	---	---	---	---	---	---	---	---	---
BC148155_IGLC3 <sup>a</sup>	569	...	...	...	...	...	...	...	...	...	...	...	...	---	---	---	---	---	---	---	---	---	---	---	---	---	---
NM_001083800_IGLC3 <sup>a</sup>	595	...	...	...																							

		E														EF	
		A	S	S	Y	L	S	L	T	S	S	D	W	.	.		
DQ537487_IGLC3	18797	GCC	AGC	AGC	TAC	CTG	AGC	CTG	ACG	AGC	AGC	GAC	TGG	---	---		
IGLC3 <sup>a</sup>	202	...	...	...	...	...	...	...	...	...	...	...	...	---	---		
IGLC3 <sup>b</sup>	202	...	...	...	...	...	...	...	<i>A</i>	<i>GA</i>	...	...	...	---	---		
IGLC3 <sup>c</sup>	202	...	...	...	...	...	...	...	<i>G</i>	...	...	...	...	---	---		
IGLC3 <sup>d</sup>	202	...	...	...	...	...	...	...	...	...	...	...	...	---	---		
AF396698_IGLC3 <sup>e</sup>	589	...	...	...	...	...	...	...	...	...	...	...	...	---	---		
BC102189_IGLC3 <sup>a</sup>	642	...	...	...	...	...	...	...	...	...	...	...	...	---	---		
BC112657_IGLC3 <sup>d</sup>	646	...	...	...	...	...	...	...	...	...	...	...	...	---	---		
BC114801_IGLC3 <sup>a</sup>	643	...	...	...	...	...	...	...	...	...	...	...	...	---	---		
BC134589_IGLC3 <sup>a</sup>	643	...	...	...	...	...	...	...	...	...	...	...	...	---	---		
BC142355_IGLC3 <sup>a</sup>	640	...	...	...	...	...	...	...	...	...	...	...	...	---	---		
BC142384_IGLC3 <sup>a</sup>	633	...	...	...	...	...	...	...	...	...	...	...	...	---	---		
BC146272_IGLC3 <sup>a</sup>	642	...	...	...	...	...	...	...	...	...	...	...	...	---	---		
BC148155_IGLC3 <sup>a</sup>	617	...	...	...	...	...	...	...	...	...	...	...	...	---	---		
NM_001083800_IGLC3 <sup>a</sup>	643	...	...	...	...	...	...	...	...	...	...	...	...	---	---		
NW_001493546_IGLC3 <sup>a</sup>	231971	...	...	...	...	...	...	...	...	...	...	...	...	---	---		
X62917_IGLC3 <sup>a</sup>	620	...	...	...	...	...	...	...	...	...	...	...	...	---	---		
DQ537487_IGLC1	6239	...	...	...	...	...	...	...	...	<i>G</i>	...	...	...	---	---		
DQ537487_IGLC4	25067	...	...	...	...	...	...	<i>T</i>	<i>G</i>	...	...	...	...	---	---		

		F											FG									
		K	S	K	G	S	Y	S	C	E	V	T	H	E	110	111	112	113	G	S	T	V
DQ537487_IGLC3	18833	AAA	TCG	AAA	GGC	AGT	TAC	AGC	TGC	GAG	GTC	ACG	CAC	GAG	---	---	---	---	GGG	AGC	ACC	GTG
IGLC3 <sup>a</sup>	238	...	...	...	...	...	...	...	...	...	...	...	...	...	---	---	---	---	...	...	...	...
IGLC3 <sup>b</sup>	238	...	...	...	...	...	...	...	...	...	...	...	...	...	---	---	---	---	...	...	...	...
IGLC3 <sup>c</sup>	238	...	...	...	...	...	...	...	...	...	...	...	...	...	---	---	---	---	...	...	...	...
IGLC3 <sup>d</sup>	238	...	...	...	...	...	...	...	...	...	...	...	...	...	---	---	---	---	...	...	...	...
AF396698_IGLC3 <sup>e</sup>	625	...	...	...	...	...	...	...	...	...	...	...	...	...	---	---	---	---	...	...	...	...
BC102189_IGLC3 <sup>a</sup>	678	...	...	...	...	...	...	...	...	...	...	...	...	...	---	---	---	---	...	...	...	...
BC112657_IGLC3 <sup>d</sup>	682	...	...	...	...	...	...	...	...	...	...	...	...	...	---	---	---	---	...	...	...	...
BC114801_IGLC3 <sup>a</sup>	679	...	...	...	...	...	...	...	...	...	...	...	...	...	---	---	---	---	...	...	...	...
BC134589_IGLC3 <sup>a</sup>	679	...	...	...	...	...	...	...	...	...	...	...	...	...	---	---	---	---	...	...	...	...
BC142355_IGLC3 <sup>a</sup>	676	...	...	...	...	...	...	...	...	...	...	...	...	...	---	---	---	---	...	...	...	...
BC142384_IGLC3 <sup>a</sup>	669	...	...	...	...	...	...	...	...	...	...	...	...	...	---	---	---	---	...	...	...	...
BC146272_IGLC3 <sup>a</sup>	678	...	...	...	...	...	...	...	...	...	...	...	...	...	---	---	---	---	...	...	...	...
BC148155_IGLC3 <sup>a</sup>	653	...	...	...	...	...	...	...	...	...	...	...	...	...	---	---	---	---	...	...	...	...
NM_001083800_IGLC3 <sup>a</sup>	679	...	...	...	...	...	...	...	...	...	...	...	...	...	---	---	---	---	...	...	...	...
NW_001493546_IGLC3 <sup>a</sup>	232007	...	...	...	...	...	...	...	...	...	...	...	...	...	---	---	---	---	...	...	...	...
X62917_IGLC3 <sup>a</sup>	656	...	...	...	...	...	...	...	...	...	...	...	...	...	---	---	---	---	...	...	...	...
DQ537487_IGLC1	6274	...	...	...	...	...	...	...	...	...	...	...	...	...	---	---	---	---	...	...	...	...
DQ537487_IGLC4	25103	...	...	...	...	...	...	...	...	...	...	...	...	...	---	---	---	---	...	...	...	...

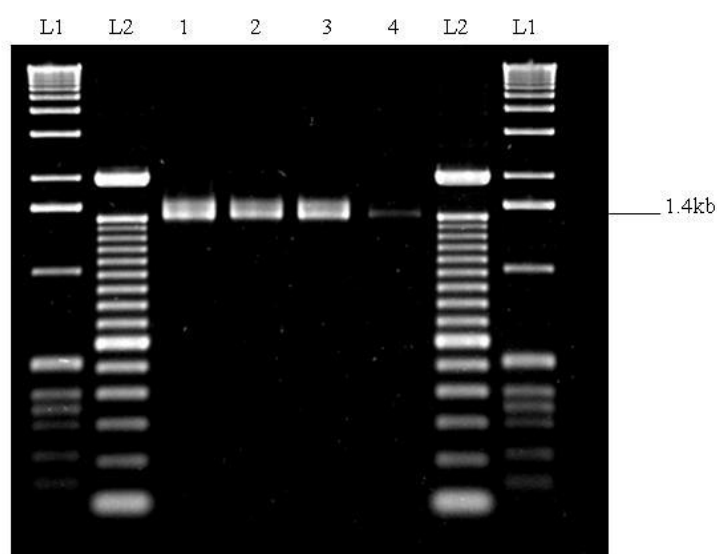
		G											*
		T	K	T	V	K	P	S	E	C	S		
DQ537487_IGLC3	18884	ACG	ARG	ACA	GTG	ARG	CCC	TCA	GAG	TGT	TCT	TAG	
IGLC3 <sup>a</sup>	289	...	...	...	...	...	...	...	...	...	...	...	
IGLC3 <sup>b</sup>	289	...	...	...	...	...	...	...	...	...	...	...	
IGLC3 <sup>c</sup>	289	...	...	...	...	...	...	...	...	...	...	...	
IGLC3 <sup>d</sup>	289	...	...	...	...	...	...	...	...	...	...	...	
AF396698_IGLC3 <sup>e</sup>	676	...	...	...	...	...	...	...	...	...	...	...	
BC102189_IGLC3 <sup>a</sup>	729	...	...	...	...	...	...	...	...	...	...	...	
BC112657_IGLC3 <sup>d</sup>	733	...	...	...	...	...	...	...	...	...	...	...	
BC114801_IGLC3 <sup>a</sup>	730	...	...	...	...	...	...	...	...	...	...	...	
BC134589_IGLC3 <sup>a</sup>	730	...	...	...	...	...	...	...	...	...	...	...	
BC142355_IGLC3 <sup>a</sup>	727	...	...	...	...	...	...	...	...	...	...	...	
BC142384_IGLC3 <sup>a</sup>	720	...	...	...	...	...	...	...	...	...	...	...	
BC146272_IGLC3 <sup>a</sup>	729	...	...	...	...	...	...	...	...	...	...	...	
BC148155_IGLC3 <sup>a</sup>	704	...	...	...	...	...	...	...	...	...	...	...	
NM_001083800_IGLC3 <sup>a</sup>	730	...	...	...	...	...	...	...	...	...	...	...	
NW_001493546_IGLC3 <sup>a</sup>	232058	...	...	...	...	...	...	...	...	...	...	...	
X62917_IGLC3 <sup>a</sup>	707	...	...	...	...	...	...	...	...	...	...	...	
DQ537487_IGLC1	6325	...	...	...	...	...	<i>A</i>	...	<i>C</i>	...	...	...	
DQ537487_IGLC4	25154	...	...	...	...	...	...	...	...	...	...	...	

**Fig. 17:** Isotype IGLC3 (DQ537487\_IGLC3) was aligned by ClustalW (Thompson *et al.*, 1994) using detected allotypes as well as all annotated database information. Sequences were numbered according to the IMGT numbering system for constant domains (Lefranc *et al.*, 2005). A, B, C, D, E, F, and G correspond to the sandwich fold beta strands, whereas AB, BC, CD, EF, and FG classify the turns and loops. Dots indicate identical nucleotides and dashes indicate gaps. The asterisk marks the stop codon. Amino acid residues that ensure the contact with CH1 within the interface between IGHC1 and IGLC in the crystal structure of human mAb NEW are indicated in bold letters. In the crystal structure of human mAb KOL they are indicated in italic letters (Padlan *et al.*, 1986). Bold and italic letters demonstrate interface residues in both of the mAbs NEW and KOL. Allotype IGLC3<sup>a</sup> and IGLC3<sup>b</sup> were detected in all of the four breeds analyzed. IGLC3<sup>c</sup> was only found in German Simmental and Aubrac. IGLC3<sup>d</sup> was found in German Simmental and Holstein Friesian. IGLC3<sup>e</sup> was found in German Simmental.

## 4.1.2 Detection of new allotypic variants of bovine IgG-heavy chain constant regions (IGHC)

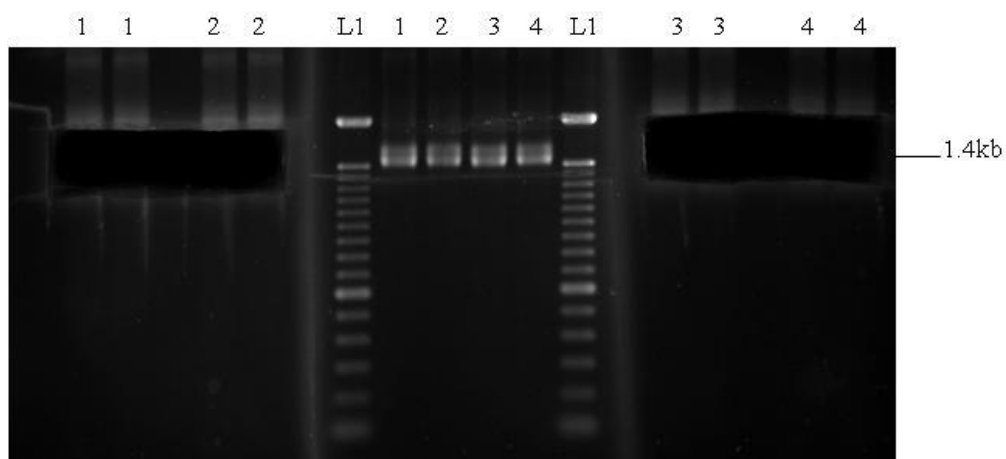
### 4.1.2.1 Amplification of the transcribed bovine IgG-heavy chain repertoire

Immunoglobulin G-heavy chain repertoire was prepared by B-cells isolation from ten animals of each breed and pooled to carry out the total RNA extraction. Total RNA was converted into cDNA, which was amplified by PCR using the designed primer set bIgG\_leader and bIgG\_3'UTR (Fig. 18). The PCR products of IgG-heavy chains were extracted from the gel and cloned into the vector (Fig. 19). Sixteen white clones per animal were chosen from LB-agar plates and plasmid DNA was isolated and cleaved with *EcoRI* (Fig. 20). Plasmid DNA was sequenced using sequencing primers bIgG\_leader, bIgG\_CH1, bIgG\_CH, bIgG\_CH3, bIgG\_3'UTR, M13 Forward, and M13 Reverse vector specific primers. The constant regions of IgG-heavy chain were separated from the variable regions.

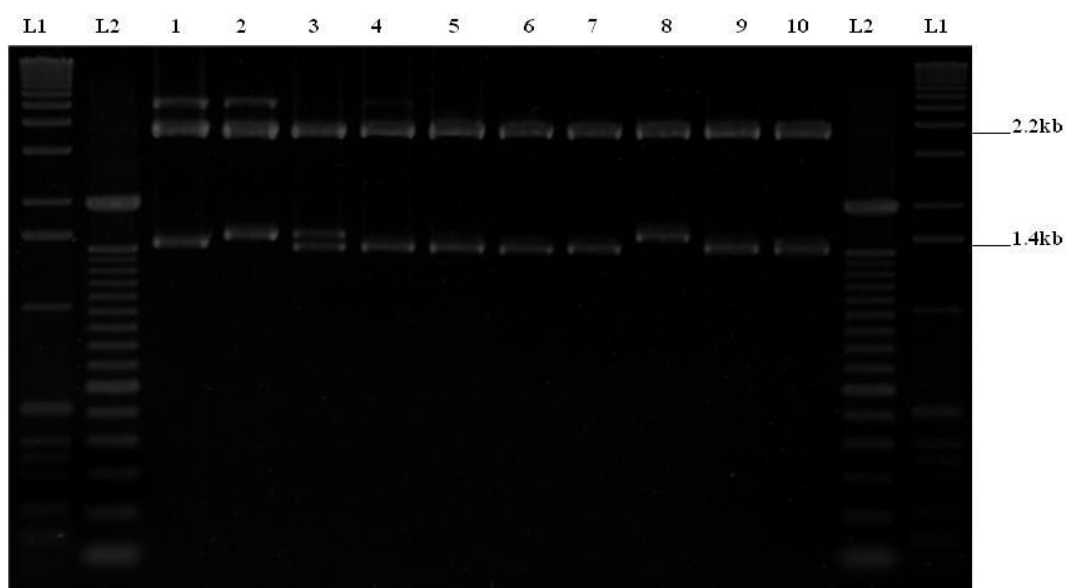


**Fig. 18:** Amplification of IgG heavy chains with primer pairs bIgG\_leader/bIgG\_3'UTR (1-4) and cDNA from four different cattle breeds. 1: German Simmental, 2: German Black Pied, 3: Holstein Friesian, 4: Aubrac, L1: 1kb ladder, and L2: 100bp ladder. The expected product sizes were 1.4kb.





**Fig. 19:** Documentation of the successful gel extraction of the PCR products of bIgG\_leader/bIgG\_3'UTR of GS. The amplified PCR products of four animals of GS were load in the middle of the gel as a control and on the outer side of two gel pieces for purification. L1 is the 100bp ladder.



**Fig. 20:** Enzyme cleaved the plasmid DNA of bIgG\_leader\_1/bIgG\_3'UTR with the restriction enzyme *EcoRI* to separate the plasmid (at 2.2kb) than DNA product (at 1.4kb) to prove that the DNA inserts in the correct size. L1: 1kb ladder, L2: 100bp ladder, clone 1-10 for the 1<sup>st</sup> animal of GS, and 2.2kb is the size of the vector.

A BLAST search of the NCBI GenBank was performed for IgG-heavy chain constant regions to assign them to the corresponding isotype (IgG1, IgG2, or IgG3). Each isotype was aligned by ClustalW with their respective database entries to classify them to the corresponding allele and allotype and to detect

presence or absence of single nucleotide polymorphisms (SNPs) in each gene that resulted in silent mutations or amino acid residue substitutions. The comparisons between our sequences and known GenBank entries were performed within one breed and among the studied cattle breeds. Most of them belonged to IgG2 with 66.1%, followed by 33.4% for IgG1, and 0.5% for IgG3. The investigation of IgG isotypes revealed the known allotypic variants of IgG2, IgG1, and one of IgG3 allotypic variants. In addition to allotypic variant of IgG1 designated IgG1<sup>e</sup>, which is assumed to be a new allotypic variant. *In silico* analyses of the ESTs database did not reveal any nucleotide sequences coding for IgG1<sup>e</sup>.

#### 4.1.2.2 Polymorphisms of isotype IgG1 within the analyzed breeds

Isotype IgG1 revealed four known allelic and allotypic variants. Our sequences were compared with four known allotypic constant regions of the GenBank entries S82409 (IgG1<sup>a</sup>), X16701 (IgG1<sup>b</sup>), DQ452014 (IgG1<sup>c</sup>), and X62916 (IgG1<sup>d</sup>).

In the analyzed breeds, Seven heterozygous and three homozygous animals were aligned to allotypic variant IgG1<sup>a</sup>, whereas allotypic variant IgG1<sup>b</sup> was expressed in six heterozygous and eleven homozygous animals. Allotypic variant IgG1<sup>d</sup> was detected in ten heterozygous and five homozygous animals. The new allelic and allotypic variant IgG1<sup>e</sup> was demonstrated in five heterozygous and four homozygous animals of breed GS. Each allotype possessed SNPs in different regions of IgG constant region.

For the known allotypic variant IgG1<sup>c</sup>, one heterozygous animal of HF was clustered to IgG1<sup>c</sup> in combination with allotypic variant IgG1<sup>b</sup>. Comparison of the sequences to the GenBank entry DQ452014\_IgG1<sup>c</sup> did not possess any SNPs with 100-99.9% identity.

##### 4.1.2.2.1 Polymorphisms of IgG1<sup>a</sup> in the analyzed cattle breeds

The alignment of two HF and one Aubrac homozygous animals and three HF, two GBP, and two GS heterozygous animals revealed the known allelic and allotypic form IgG1<sup>a</sup> represented by the GenBank entry S82409\_IgG1<sup>a</sup>-exon. These animals were grouped together phylogenetically with 99.8-98.7% identity.

Allotype IgG1<sup>a</sup> of two HF and one GBP heterozygous animals were

observed in combination with allotype IgG1<sup>d</sup>, IgG1<sup>a</sup> of the second heterozygous GBP and third HF animals was combined with allotype IgG1<sup>b</sup>. Two GS heterozygous animals showed allotype IgG1<sup>a</sup> in combination with IgG1<sup>e</sup>.

Eight SNPs were found in the CH1, CH2, and CH3 domains of GBP and GS, nine SNPs were possessed in the CH1, CH2, and CH3 of one GBP animal, two SNPs were found in the CH1 and CH2 of HF and Aubrac, and three SNPs in the CH1 and CH2 in ten sequences of four HF animals.

In the CH1 region of GBP and GS, six SNPs were monitored at positions S82409:g.63C>G, 64A>G, 65C>G, 66C>G, 218G>C, 224C>G according to Eu numbering system. Five SNPs led to amino acid residue substitutions within the CH1 region, SNPs64, 65, and 66 replaced polar T139 by nonpolar G139, SNP218 switched the codon G190 into A190, and both amino acid residues 139 and 190 are located in the CH1-CL interface. SNP224 substituted T192 by S192, which was located in the inner surface with a neutral charge.

The remaining SNP63 caused a silent mutation in S138. Three bases were absent at positions 232A, 233C, 234C resulting in deletion of an amino acid residue T195 of the CH1 region that may decrease the polarity. One SNP was detected at position 628A>G of the CH2 domain causing a silent mutation in P327. In the CH3 domain, one SNP was found at position 979G>C which substituted A445 by P445 in GBP and GS. In one GBP animal, the described SNPs were found and in addition, one SNP at position 940C>T was detected within the CH3 domain leading to silent mutations in A432.

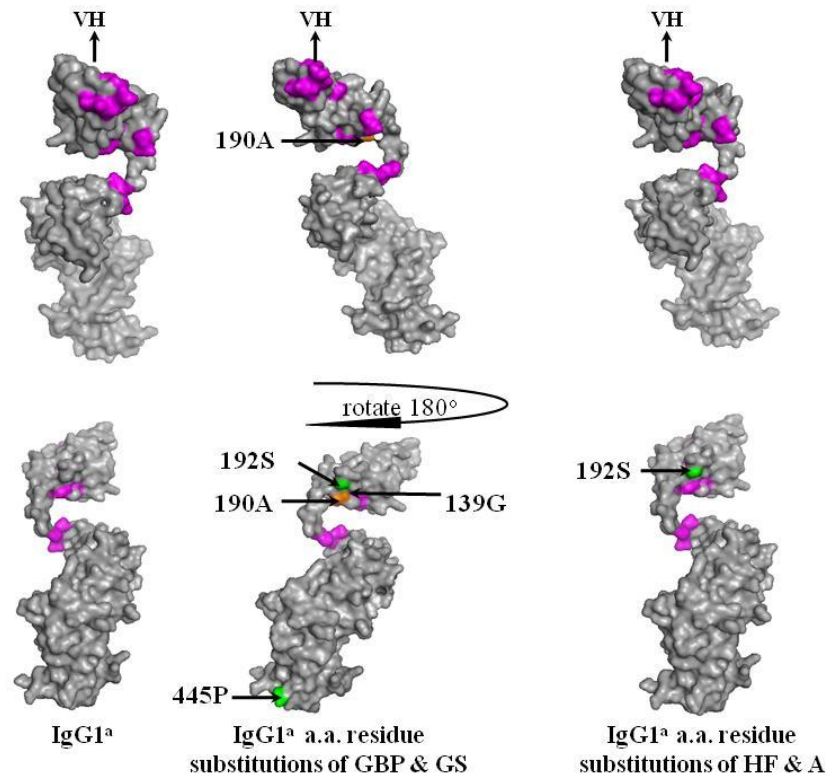
Aubrac and HF possessed only one SNP at position 224 of the CH1 domain and the absence of three bases at positions 232, 233, and 234. The SNP628 of the CH2 region was also detected. Ten sequences of four animals of HF showed two SNPs in the CH1 region at positions 87C>G and 165C>T causing a silent mutation of V146 and A172, respectively (Fig. 21, 22).

```

118                                     145
  A S T T A P K V Y P L S S C C G D K S S S T V T L G C L CH1
1 GCC TCC ACC ACA GCC CCG AAA GTC TAC CCT CTG AGT TCT TGC TGC GGG GAC AAG TCC ACC GTG ACC CTG GGC TGC CTG S82409
1 ... .. .G GGG ... .. . GBP/GS
1 ... .. .G GGG ... .. . GBP
1 ... .. . HF/A
1 ... .. . HF
146                                     173
  V S S Y M P E P V T V T W N S G A L K S G V H T F P A V
85 GTC TCC AGC TAC ATG CCC GAG CCG GTG ACC GTG ACC TGG AAC TCG GGT GCC CTG AAG AGC GGC GTG CAC ACC TTC CCG GCC GTC S82409
85 ... .. . GBP/GS
85 ... .. . GBP
85 ... .. . HF/A
85 ..G ... .. .T ... HF
174                                     201
  L Q S S G L Y S L S S M V T V P G S T S G T Q T F T C N
169 CTT CAG TCC TCC GGG CTC TAC TCT CTC AGC AGC ATG GTG ACC GTG CCC GGC AGC ACC TCA GGA ACC CAG ACC TTC ACC TGC AAC S82409
169 ... .. .C. ... .G. ... --- ... .. . GBP/GS
169 ... .. .C. ... .G. ... --- ... .. . GBP
169 ... .. .G. ... --- ... .. . HF/A
169 ... .. . HF
202                                     CH1 Hinge region CH2 229
  V A H P A S S T K V D K A V D P R C K T T C D C C P P P
253 GTA GCC CAC CCG GCC AGC AGC ACC AAG GTG GAC AAG GCT GTT GAT CCC AGA TGC AAA ACA ACC TGT GAC TGT TGC CCA CCG CCT S82409
253 ... .. . GBP/GS
253 ... .. . GBP
253 ... .. . HF/A
253 ... .. . HF
230                                     257
  E L P G G P S V F I F P P K P K D T L T I S G T P E V T
337 GAG CTC CCT GGA GGA CCC TCT GTC TTC ATC TTC CCA CCG AAA CCC AAG GAC ACC CTC ACA ATC TCG GGA AGC CCC GAG GTC ACG S82409
337 ... .. . GBP/GS
337 ... .. . GBP
337 ... .. . HF/A
337 ... .. . HF
258                                     285
  C V V V D V G H D D P E V K F S W F V D D V E V N T A T
421 TGT GTG GTG GTG GAC GTG GGC CAC GAT GAC CCC GAG GTG AAG TTC TCC TGG TTC GTG GAC GAC GTG GAG GTA AAC ACA GCC ACG S82409
421 ... .. . GBP/GS
421 ... .. . GBP
421 ... .. . HF/A
421 ... .. . HF
286                                     313
  T K P R E E Q F N S T Y R V V S A L R I Q H Q D W T G G
505 ACG AAG CCG AGA GAG GAG CAG TTC AAC AGC ACC TAC CGC GTG GTC AGC GCC CTG CGC ATC CAG CAC CAG GAC TGG ACT GGA GGA S82409
505 ... .. . GBP/GS
505 ... .. . GBP
505 ... .. . HF/A
505 ... .. . HF
314                                     CH2 CH3 341
  K E F K C K V H N E G L P A P I V R T I S R T K G P A R
589 AAG GAG TTC AAG TGC AAG GTC CAC AAC GAA GGC CTC CCA GCC CCC ATC GTG AGG ACC ATC TCC AGG ACC AAA GGG CCG GCC CGG S82409
589 ... .. .G ... .. . GBP/GS
589 ... .. .G ... .. . GBP
589 ... .. .G ... .. . HF/A
589 ... .. .G ... .. . HF
342                                     369
  E P Q V Y V L A P P Q E E L S K S T V S L T C M V T S F
673 GAG CCG CAG GTG TAT GTC CTG GCC CCA CCC CAG GAA GAG CTC AGC AAA AGC ACG GTC AGC CTC ACC TGC ATG GTC ACC AGC TTC S82409
673 ... .. . GBP/GS
673 ... .. . GBP
673 ... .. . HF/A
673 ... .. . HF

```





**Fig. 22:** Homology based modeling of isotype IgG1 allotypic variant IgG1<sup>a</sup> of GBP, GS, HF, and A. Solvent accessible surface views are shown for the predicted 3D structures from two opposite sides. The images at the bottom are turned by 180° over the vertical axis compared to those at the top. The putative interface to CL derived from the crystal structure of the human mAb NEW is magenta. Locations of amino acid (a.a.) residue differences to the basic allotype IgG1<sup>a</sup> within the putative interface are marked in orange, whereas the remaining substitutions are marked in green. VH indicates the location of the corresponding variable region. The description of the amino acid residues corresponds to the Eu index nomenclature.

#### 4.1.2.2.2 Polymorphisms of IgG1<sup>b</sup> in the analyzed cattle breeds

In addition to IgG1<sup>a</sup>, the known allotypic form IgG1<sup>b</sup> was expressed in four GBP, one HF, and six Aubrac homozygous animals, in addition to three GBP and three HF heterozygous animals, which were represented by the GenBank entry X16701\_IgG1<sup>b</sup>-exon with 99.9-98.8% identity, and was not expressed in GS.

IgG1<sup>b</sup> was detected in two GBP and two HF heterozygous animals in combination with IgG1<sup>d</sup>, the third heterozygous animal of GBP showed both allotypes IgG1<sup>a</sup> and IgG1<sup>b</sup>, whereas the third HF heterozygous animal possessed IgG1<sup>b</sup> and IgG1<sup>c</sup>.

Three SNPs in the CH1 domain of allotype IgG1<sup>b</sup> were detected in four animals of GBP constant region. The SNPs of the CH1 domain were found at positions 87C>G, 186G>C, and 224C>G. The SNPs at positions 87 and 186 led to silent mutation of allotype IgG1<sup>b</sup> in V146 and L179, respectively, while T192 was substituted by S192 due to base change at position 224. One animal of GBP possessed one SNP at the CH3 domain at position 937C>T causing a silent mutation in A431, in addition to SNPs 186 and 224. Holstein Friesian and Aubrac showed only two SNPs at position 186 and 224 (Fig. 23, 24).

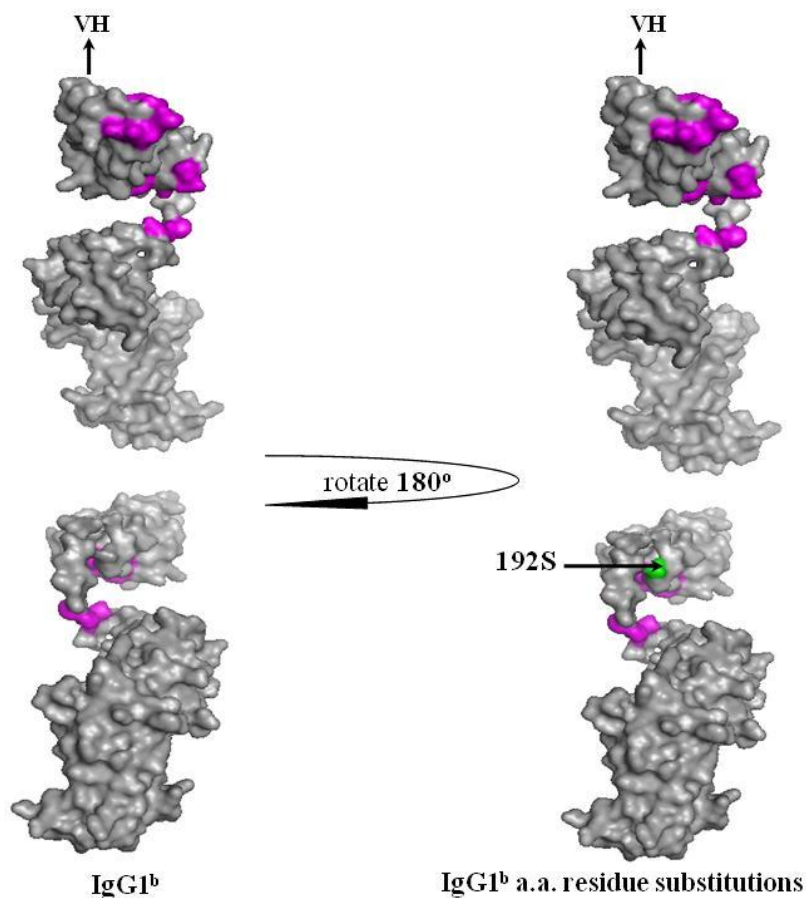
```

118                                     145
  A S T T A P K V Y P L S S C C G D K S S S T V T L G C L CH1
1 GCC TCC ACC ACA GCC CCG AAA GTC TAC CCT CTG AGT TCT TGC TGC GGG GAC AAG TCC AGC TCC ACC GTG ACC CTG GGC TGC CTG X16701
1 . . . . . GBP
1 . . . . . GBP
1 . . . . . HF/A
146                                     173
  V S S Y M P E P V T V T W N S G A L K S G V H T F P A V
85 GTC TCC AGC TAC ATG CCC GAG CCG GTG ACC GTG ACC TGG AAC TCG GGT GCC CTG AAG AGC GGC GTG CAC ACC TTC CCG GCC GTC X16701
85 . . G . . . . . GBP
85 . . . . . GBP
85 . . G . . . . . HF/A
174                                     201
  L Q S S G L Y S L S S M V T V P G S T S G Q T F T C N V
169 CTT CAG TCC TCC GGG CTG TAC TCT CTC AGC AGC ATG GTG ACC GTG CCC GGC AGC ACC TCA GGA CAG ACC TTC ACC TGC AAC GTA X16701
169 . . . . .C . . . . . GBP
169 . . . . .G. . . . . GBP
169 . . . . .C . . . . . HF/A
427                                     447
  V M H E A L H N H Y T Q K S T S K S A G K .
922 GTG ATG CAC GAG GCC CTG CAC AAT CAC TAC ACG CAG AAG TCC ACC TCT AAG TCT GCG GGT AAA TGA X16701
922 . . . . . GBP
922 . . . . . T. . . . . GBP
922 . . . . . . . . . . HF/A

```

**Fig. 23:** The nucleotide sequences and amino acid residues of isotype IgG1 allotypic variant IgG1<sup>b</sup> of the three cattle breeds (GBP, HF, and A) were compared with the sequence of bovine IgG1<sup>b</sup> (GenBank X16701). The sequences presenting CH1 domain and a part of CH3 domain, which possessed the SNPs of the IgG1<sup>b</sup> allele. Identical nucleotides are indicated with dots (.). The

horizontal numbers indicated to the amino acid residues and the vertical numbers indicated to the nucleotide sequences of the IgG1<sup>b</sup> allotype.



**Fig. 24:** Homology based modeling of isotype IgG1 allotypic variant IgG1<sup>b</sup> of GBP, HF, and A. Solvent accessible surface views are shown for the predicted 3D structures from two opposite sides. The images at the bottom are turned by 180° over the vertical axis compared to those at the top. The putative interface to CL derived from the crystal structure of the human mAb NEW is magenta. Locations of amino acid (a.a.) residue differences to the basic allotype IgG1<sup>b</sup> are marked in green. VH indicates the location of the corresponding variable region. The description of the amino acid residues corresponds to the Eu index nomenclature.



#### 4.1.2.2.3 Polymorphisms of IgG1<sup>d</sup> in the analyzed cattle breeds

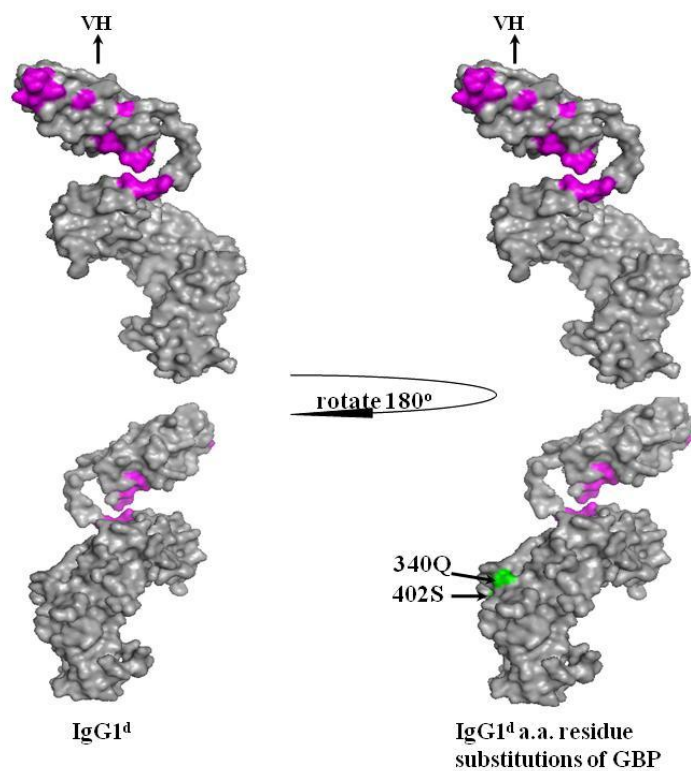
The sequenced clones that belonged to IgG1<sup>d</sup> were compared to the GenBank entries X62916\_IgG1<sup>d</sup>-exons and two clones (BC146168 and BC147881), which have the same nucleotide sequences of X62916\_IgG1<sup>d</sup>-exons except two bases at position 218G>C and 224 C>G. The base changes at position 218 and 224 led to amino acid residue changes at G190A and T192S, respectively.

The allotype IgG1<sup>d</sup> was expressed in three GBP, four HF and three GS heterozygous animals and two GBP, two HF, and one GS homozygous animals, which means that this allotypic variant was absent in Aubrac. This group of animals aggregated together to allotype IgG1<sup>d</sup> with 100-99.7% identity more than the other allotypes.

The allotype IgG1<sup>d</sup> of two GBP heterozygous animals was combined with allotype IgG1<sup>b</sup>, while the third animal possessed allotype IgG1<sup>d</sup> in combination with IgG1<sup>a</sup>. Although two heterozygous animals of HF showed allotype IgG1<sup>d</sup> in combination with allotype IgG1<sup>a</sup>, the other two animals possessed allotype IgG1<sup>d</sup> in combination with IgG1<sup>b</sup>. Allotype IgG1<sup>d</sup> of three GS heterozygous animals was in combination with IgG1<sup>e</sup>.

In GBP, four heterozygous and homozygous animals have the same sequences of X62916\_IgG1<sup>d</sup>-exons and did not possess any SNPs, only one animal was belonged to BC146168 and BC147881. This animal possessed one SNP at position 87C>G in the CH1 domain and Four SNPs at positions 668C>A, 795C>T, 834G>T, and 853A>G in the CH3 domain. On the other hand, three bases were inserted at positions 232A, 233C, and 234C resulting in the insertion of an amino acid residue T195 in the CH1 region of IgG1<sup>d</sup>, whereas the SNP at positions 87 led to silent mutation in V146. In the CH3 domain, the SNPs at positions 668 and 853 replaced the nonpolar amino acid residues P340 and G402 by polar Q340 and S402, respectively, whereas the other two SNPs at positions 795 and 834 led to silent mutation in N382 and P395, respectively. The amino acid substitutions Q340 and S402 were located in the inner surface of the molecule. In HF animals, all animals were identical to BC146168 and BC147881 with one SNP at position 186G>C, which caused a silent mutation in L179. In GS, the animals showed the same sequences of allotype X62916\_IgG1<sup>d</sup> with one SNP in the CH1 region at position 186 (Fig. 25, 26).





**Fig. 26:** Homology based modeling of isotype IgG1 allotypic variant IgG1<sup>d</sup> of GBP. Solvent accessible surface views are shown for the predicted 3D structures from two opposite sides. The images at the bottom are turned by 180° over the vertical axis compared to those at the top. The putative interface to CL derived from the crystal structure of the human mAb NEW is magenta. Locations of amino acid (a.a.) residue differences to the basic allotype IgG1<sup>d</sup> are marked in green. VH indicates the location of the corresponding variable region. The description of the amino acid residues corresponds to the Eu index nomenclature.

#### 4.1.2.2.4 The New allele of IgG1 found in German Simmental designated IgG1<sup>e</sup>

The allele of IgG1 isotype, which is assumed to be a new allele in the present study, was found in four homozygous animals and five heterozygous animals of GS, which phylogenetically grouped together apart from the other known alleles with 87.2% identity. The assumed allotypic variant IgG1<sup>e</sup> of three heterozygous animals was detected in combination with IgG1<sup>d</sup>, whereas in the other two animals it combined with IgG1<sup>a</sup>.

Allotype IgG1<sup>e</sup> was compared to the known four allotypes S82409-IgG1<sup>a</sup>, X16701-IgG1<sup>b</sup>, DQ452014-IgG1<sup>c</sup>, and X62916\_IgG1<sup>d</sup>, and revealed SNPs in each part of the constant region (CH1, hinge region, CH2, and CH3) differing than four allotypes. The SNPs of the CH1 domain were detected at positions 63C>G, 64 A>G, 65C>G, 66C>G of the four previous accession numbers. SNP64, 65, and 66 replaced polar T139 by nonpolar G139 in the CH1-CL interface, while the remaining SNP 63 caused a silent mutation in S138. The SNPs of the hinge region were at positions 313T>C, 314C>T, and 317C>G. The changes at position 313 and 314 switched the code of polar S222 to nonpolar L222 and the exchange at position 317 led to the amino acid residue substitution of nonpolar P223 to polar R223 causing a positive charge. The position 602A>C of the CH2 substituted amino acid residue K318 by T318 and the SNP668C>A of the CH3 region led to the change of the amino acid residue from nonpolar P340 to polar Q340. Amino acids 318 and 340 were located in the inner surface of the CH2-CH2 and CH3-CH3 of immunoglobulin, respectively (Fig. 27, 28).

```

118                                     145
  A S T T A P K V Y P L S S C C G D K S S S T V T L G C L CH1
1  GCC TCC ACC ACA GCC CCG AAA GTC TAC CCT CTG AGT TCT TGC TGC GGG GAC AAG TCC AGC TCC ACC GTG ACC CTG GGC TGC CTG S82409
1  ... .. X16701
1  ... .. DQ452014
1  ... .. X62916
1  ... .. Igg1e
146                                     173
  V S S Y M P E P V T V T W N S G A L K S G V H T F P A V
85  GTC TCC AGC TAC ATG CCC GAG CCG GTG ACC GTG ACC TGG AAC TCG GGT GCC CTG AAG AGC GGC GTG CAC ACC TTC CCG GCC GTC S82409
85  ... .. X16701
85  ... .. DQ452014
85  ... .. X62916
85  ... .. Igg1e
174                                     201
  L Q S S G L Y S L S S M V T V P G S T S G T Q T F T C N
169  CTT CAG TCC TCC GGG CTC TAC TCT CTC AGC AGC ATG GTG ACC GTG CCC GGC AGC ACC TCA GGA ACC CAG ACC TTC ACC TGC AAC S82409
169  ... .. X16701
169  ... .. DQ452014
169  ... .. X62916
169  ... .. Igg1e
202                                     CH1 ← Hinge → CH2 229
  V A H P A S S T K V D K A V D P R C K T . T C D C C P P
253  GTA GCC CAC CCG GCC AGC AGC ACC AAG GTG GAC AAG GCT GTT GAT CCC AGA TGC AAA ACA --- ACC TGT GAC TGT TGC CCA CCG S82409
253  ... .. X16701
253  ... .. DQ452014
253  ... .. X62916
253  ... .. Igg1e
230                                     257
  P E L P G G P S V F I F P P K P K D T L T I S G T P E V
337  CCT GAG CTC CCT GGA GGA CCC TCT GTC TTC ATC TTC CCA CCG AAA CCC AAG GAC ACC CTC ACA ATC TCG GGA ACG CCC GAG GTC S82409
337  ... .. X16701
337  ... .. DQ452014
337  ... .. X62916
337  ... .. Igg1e
258                                     285
  T C V V V D V G H D D P E V K F S W F V D D V E V N T A
421  ACG TGT GTG GTG GTG GAC GTG GGC CAC GAT GAC CCC GAG GTG AAG TTC TCC TGG TTC GTG GAC GAC GTG GAG GTA AAC ACA GCC S82409
421  ... .. X16701
421  ... .. DQ452014
421  ... .. X62916
421  ... .. Igg1e
286                                     313
  T T K P R E E Q F N S T Y R V V S A L R I Q H Q D W T G
505  ACG ACG AAG CCG AGA GAG GAG CAG TTC AAC AGC ACC TAC CGC GTG GTC AGC GCC CTG CGC ATC CAG CAC CAG GAC TGG ACT GGA S82409
505  ... .. X16701
505  ... .. DQ452014
505  ... .. X62916
505  ... .. Igg1e
314                                     CH2 → CH3 341
  G K E F K C K V H N E G L P A P I V R T I S R T K G P A
589  GGA AAG GAG TTC AAG TGC AAG GTC CAC AAC GAA GGC CTC CCA GCC CCC ATC GTG AGG ACC ATC TCC AGG ACC AAA GGG CCG GCC S82409
589  ... .. X16701
589  ... .. DQ452014
589  ... .. X62916
589  ... .. Igg1e
342                                     369
  R E P Q V Y V L A P P Q E E L S K S T V S L T C M V T S
673  CGG GAG CCG CAG GTG TAT GTC CTG GCC CCA CCC CAG GAA GAG CTC AGC AAA AGC ACG GTC AGC CTC ACC TGC ATG GTC ACC AGC S82409
673  ... .. X16701
673  ... .. DQ452014
673  ... .. X62916
673  ... .. Igg1e

```



---

IgG1<sup>c</sup>, and IgG1<sup>d</sup> within the putative interface are marked in orange, whereas the remaining substitutions are marked in green. VH indicates the location of the corresponding variable region. The description of the amino acid residues corresponds to the Eu index nomenclature.

### 4.1.2.3 Polymorphism of isotype IgG2 in the analyzed cattle breeds

The IgG2 was the major detected isotype within the sequenced clones of our analyzed breeds. The comparison of these clones with the two known alleles and allotypes GenBank entries S82407\_IgG2<sup>b</sup>-exon and X16702\_IgG2<sup>a</sup>-exon (clone 32.2.8) were performed, reflecting that 84.8% of them belonged to IgG2<sup>a</sup> and the remaining 15.2% belonged to IgG2<sup>b</sup>. The IgG2<sup>a</sup> was expressed by two different sequences (clone 32.2.8 and clone 2.26) reported by Symons *et al* (1989). Ten GBP, five Aubrac, nine GS, and three HF homozygous animals belonged to allotype IgG2<sup>a</sup>. In addition, four heterozygous animals of Aubrac, one GS, and seven HF were assigned to this allotype. The allotype IgG2<sup>b</sup> was expressed in one GS, seven HF, and three Aubrac heterozygous animals and one homozygous animal of Aubrac, while allotype IgG2<sup>b</sup> lacked in GBP.

#### 4.1.2.3.1 Polymorphisms of IgG2<sup>a</sup> in the analyzed cattle breeds

The analyzed animals of four cattle breed sequences belonged to IgG2<sup>a</sup> were compared to the GenBank entry X16702\_clone 32.2.8 and clone 2.26. Most clones (72.3%) of the animals were identical to the Genbank entries, whereas the rest (27.7%) showed three SNPs in the CH1 and one in the CH3 domains of allele IgG2<sup>a</sup> in comparison to clone 2.26. On the other hand, two nucleotide changes in the CH1, two in the CH2 and one in the CH3 domains comparing with clone 32.2.8.

The SNPs of clone 2.26 were detected at positions 35G>C, 65C>G, 66C>G, and 87C>G of the CH1 domain. The SNP at position 35 caused the amino acid residue substitution of S129>T129 in the CH1-CL interface, in contrast to the base exchanges at positions 65, 66, and 87, which led to silent mutation of M139 and V146, respectively. The SNP in the CH3 domain was at position 727C>G which did not switch the codon of T362.

The comparison to clone 32.2.8 showed two SNPs of CH1 at positions 35G>C as detected in sequences belonging to clone 2.26 and 144C>T that caused a silent mutation of S165 beside the absence of three bases at positions 232A, 233C, and 234C. The two SNPs of the CH2 were detected at positions 401C>A which substituted T251 by K251 causing positive charge in the inner side of the CH2 domain interface and 405C>T which led to a silent mutation of P252. The



last SNP was detected in the CH3 domain at position 672G>A causing a silent mutation in E341 (Fig. 29, 30).

```

118                                     145
  A S T T A P K V Y P L S S C C G D K S S S G V T L G C L CH1
1 GCC TCC ACC ACA GCC CCG AAA GTC TAC CCT CTG AGT TCT TGC TGC GGG GAC AAG TCC AGC TCG GGG GTG ACC CTG GGC TGC CTG X16702-32.2.8
1 .....C.....CC.....GBP/GS/HF/A
1 .....C ACC.....Clone 2.26
1 .....C.....GG.....GBP/GS/HF/A

146                                     173
  V S S Y M P E P V T V T W N S G A L K S G V H T F P A V
85 GTC TCC AGC TAC ATG CCC GAG CCG GTG ACC GTG ACC TGG AAC TCG GGT GCC CTG AAG AGC GGC GTG CAC ACC TTC CCG GCC GTC X16702-32.2.8
85 .....GBP/GS/HF/A
85 ..G.....Clone 2.26
85 .....GBP/GS/HF/A

174                                     201
  L Q S S G L Y S L S S M V T V P A S S S G Q T F T C N
169 CTT CAG TCC TCC GGG CTC TAC TCT CTC AGC AGC ATG GTG ACC GTG CCC GCC AGC AGC TCA GGA ACC CAG ACC TTC ACC TGC AAC X16702-32.2.8
169 .....GBP/GS/HF/A
169 .....G.....C.....Clone 2.26
169 .....GBP/GS/HF/A

202                                     229
  V A H P A S S T K V D K A V G V S I D C S K P N N Q P C
253 GTA GCC CAC CCG GCC AGC AGC ACC AAG GTG GAC AAG GCT GTT GGG GTC TCC AGT GAC TGC TCC AAG CCT AAT AAC CAG CAT TGC X16702-32.2.8
253 .....GBP/GS/HF/A
253 .....Clone 2.26
253 .....GBP/GS/HF/A

230                                     257
  V R E P S V F I F P P K P K D T L M I T G T P E V T C V
337 GTG AGG GAA CCA TCT GTC TTC ATC TTC CCA CCG AAA CCC AAA GAC ACC CTG ATG ATC ACA GGA ACG CCC GAG GTC ACG TGT GTG X16702-32.2.8
337 .....GBP/GS/HF/A
337 .....Clone 2.26
337 .....GBP/GS/HF/A

258                                     285
  V V N V G H D N P E V Q F S W F V D D V E V H T A R S K
421 GTG GTG AAC GTG GGC CAC GAT AAC CCC GAG GTG CAG TTC TCC TGG TTC GTG GAC GAC GTG GAG GTG CAC ACG GCC AGG ACG AAG X16702-32.2.8
421 .....GBP/GS/HF/A
421 .....Clone 2.26
421 .....GBP/GS/HF/A

286                                     313
  P R E E Q F N S T Y R V V S A L P I Q H Q D W T G G K E
505 CCG AGA GAG GAG CAG TTC AAC AGC ACG TAC CCG GTG GTC AGC GCC CTG CCC ATC CAG CAC CAG GAC TGG ACT GGA GGA AAG GAG X16702-32.2.8
505 .....GBP/GS/HF/A
505 .....Clone 2.26
505 .....GBP/GS/HF/A

314                                     341
  F K C K V N I K G L S A S I V R I I S R S K G P A R E P
589 TTC AAG TGC AAG GTC AAC ATC AAA GGC CTC TCG GCC TCC ATC GTG AGG ATC ATC TCC AGG AGC AAA GGG CCG GCC CGG GAG CCG X16702-32.2.8
589 .....GBP/GS/HF/A
589 .....Clone 2.26
589 .....GBP/GS/HF/A

342                                     369
  Q V Y V L D P P K E E L S K S T V S L T C M V I G F Y P
673 CAG GTG TAT GTC CTG GAC CCA CCC AAG GAA GAG CTC AGC AAA AGC ACG GTC AGC CTC ACC TGC ATG GTC ATC GGC TTC TAC CCA X16702-32.2.8
673 .....G.....GBP/GS/HF/A
673 .....Clone 2.26
673 .....C.....GBP/GS/HF/A

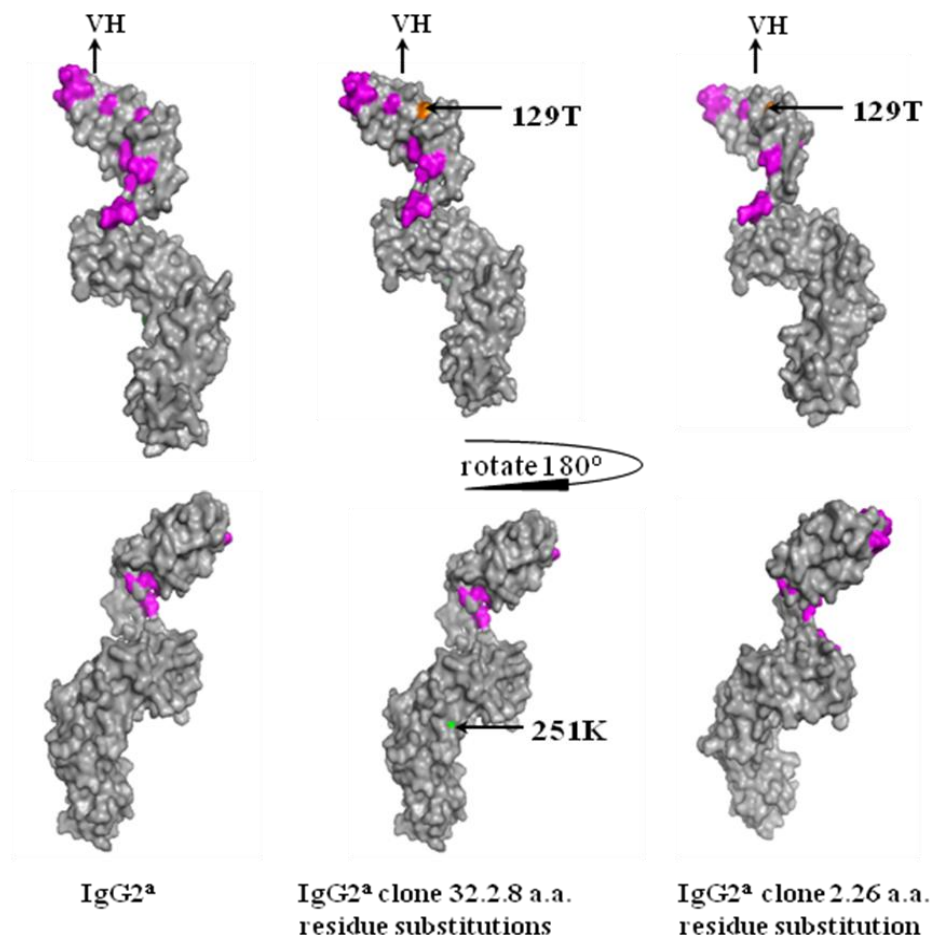
370                                     397
  E D V D V E W Q R D R Q T E S E D K Y R T T P P Q L D T
757 GAA GAT GTA GAC GTG GAG TGG CAG AGA GAC CCG CAG ACT GAG TCG GAG GAC AAG TAC CGC ACG ACC CCG CCC CAG CTG GAC GCC X16702-32.2.8
757 .....GBP/GS/HF/A
757 .....Clone 2.26
757 .....GBP/GS/HF/A

398                                     425
  D R S Y F L Y S K L R V D R N S W Q R G D T Y T C V V M
841 GAC CGC TCC TAC TTC CTG TAC AGC AAG CTC AGG GTG GAC AGG AAC AGC TGG CAG AGA GGA GAC ACC TAC ACG TGT GTG GTG ATG X16702-32.2.8
841 .....GBP/GS/HF/A
841 .....Clone 2.26
841 .....GBP/GS/HF/A

426                                     444
  H E A L H N H Y M Q K S T S K S A G K .
925 CAC GAG GCC CTG CAC AAT CAC TAC ATG CAG AAG TCC ACC TCT AAG TCT GCG GGT AAA TGA X16702-32.2.8
925 .....GBP/GS/HF/A
925 .....Clone 2.26
925 .....GBP/GS/HF/A

```

**Fig. 29:** The nucleotide sequences and amino acid residues of isotype IgG2 allotypic variant IgG2<sup>a</sup> of four breeds GBP, GS, HF, and A were compared with the sequences of bovine IgG2<sup>a</sup> (GenBank X16702-clone 32.2.8) and clone 2.26. The sequences presenting SNPs of the IgG2<sup>a</sup> allele. Identical nucleotides are indicated with dots (.) and gaps in the sequence alignment are highlighted by dashes (-). The Eu index has been used for numbering as previously reported. The horizontal numbers indicated to amino acid residues and the vertical numbers indicated to the nucleotide sequences of the IgG2<sup>a</sup> allotype.

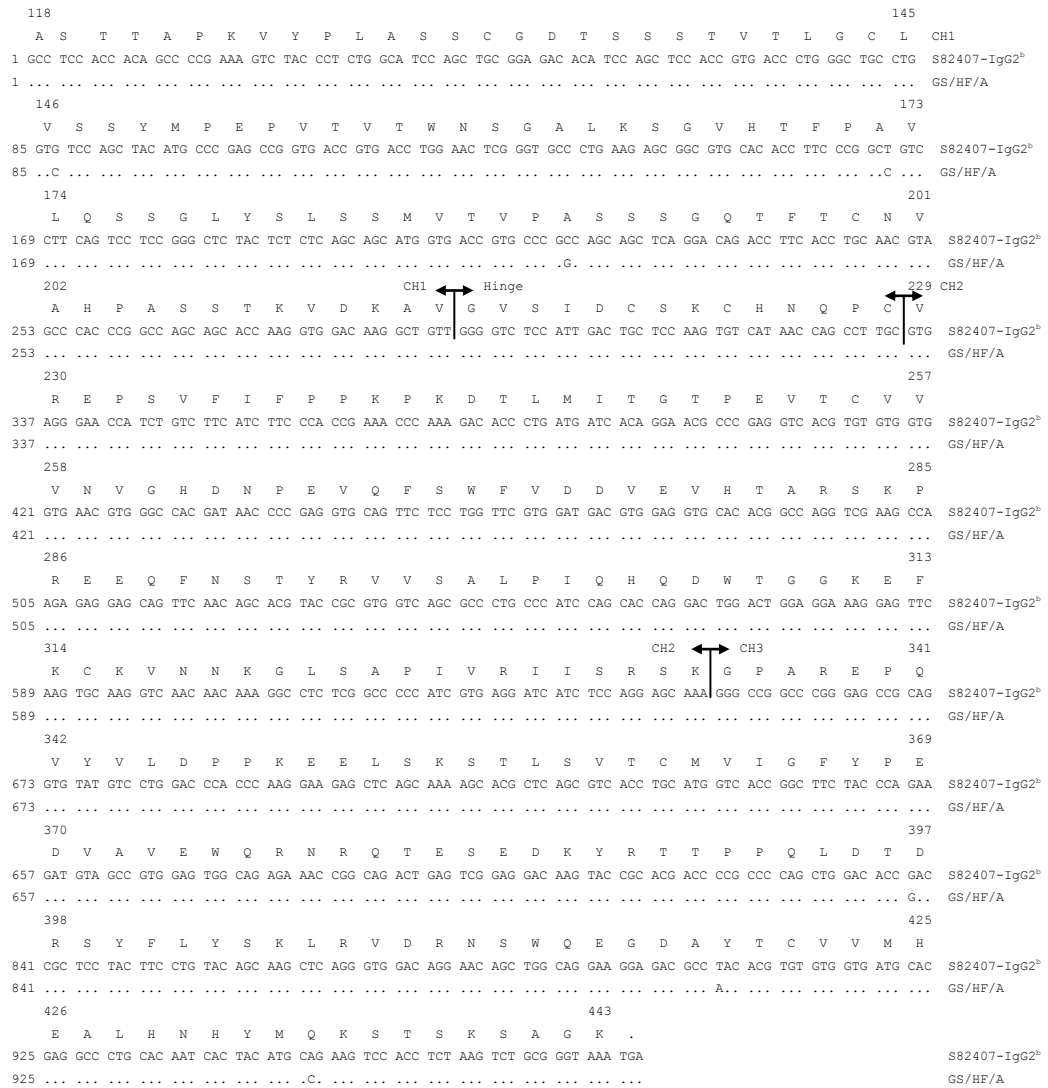


**Fig. 30:** Homology based modeling of isotype IgG2 allotypic variant IgG2<sup>a</sup> of clone 32.2.8 and 2.26. Solvent accessible surface views are shown for the predicted 3D structures from two opposite sides. The images at the bottom are turned by 180° over the vertical axis compared to those at the top. The putative interface to CL derived from the crystal structure of the human mAb NEW is magenta. Locations of amino acid (a.a.) residue differences to the basic allotype IgG2<sup>a</sup> within the putative interface are marked in orange, whereas the remaining substitution is marked in green. VH indicates the location of the corresponding variable region. The description of the amino acid residues corresponds to the Eu index nomenclature.

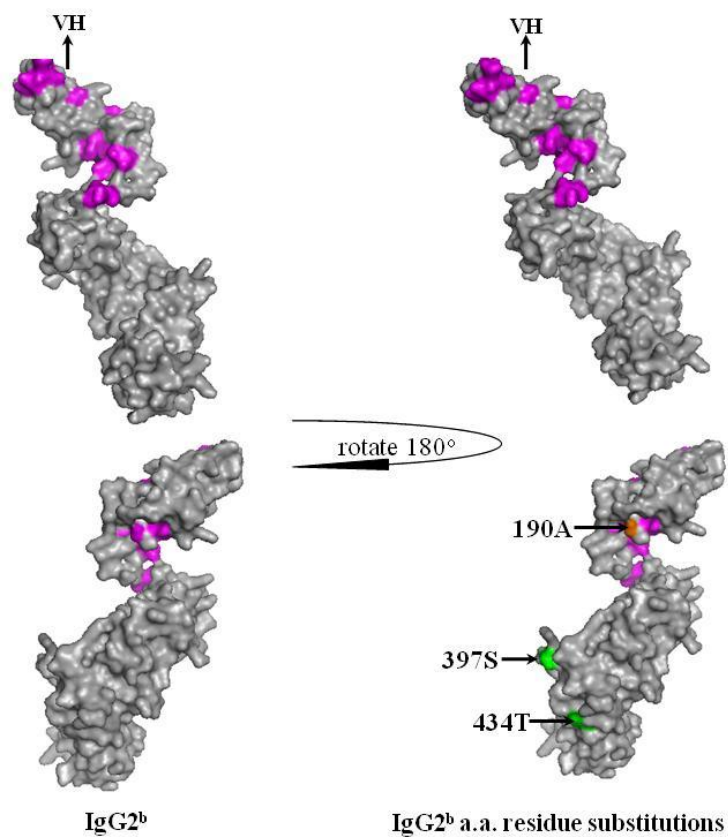
#### **4.1.2.3.2 Polymorphisms of IgG2<sup>b</sup> in the analyzed cattle breeds**

Specific clones of HF, Aubrac, and GS animals were identical to the GenBank entry S82407\_IgG2<sup>b</sup>-exon, while the other clones showed three nucleotide changes in the CH1 region and three changes in the CH3 domain from the known sequences, which were at positions 87G>C, 165T>C, and 218C>G of the CH1 and 838A>G, 904G>A, and 950T>C of the CH3.

The base changes at positions 87 and 165 of the CH1 and 904 of the CH3 led to silent mutations of V146, A172, and R421, respectively, while the SNPs 218, 838, and 950 substituted amino acids G190 by A190, R397 by S397, and nonpolar M434 by polar T434 (Fig. 31, 32). Interestingly, the nucleotide changes at position 838 and 950 were absent in HF, whereas the substitution at position 950 was absent in GS. Amino acid residue R397S caused a charge change from negative charge to neutral in the inner side of the CH2 domain. Amino acid residue M434T was located in the CH3-CH3 interface in addition to A190, which was located in CL-CH1 interface.



**Fig. 31:** The nucleotide sequences and amino acid residues of isotype IgG2 allotypic variant IgG2<sup>b</sup> of the three breeds GS, HF, and A were compared with the sequence of bovine IgG2<sup>b</sup> (GenBank S82407). The sequences presenting SNPs of the IgG2<sup>b</sup> allele. Identical nucleotides are indicated with dots (.). The Eu index has been used for numbering as previously reported. The horizontal numbers indicated to amino acid residues and the vertical numbers indicated to the nucleotide sequences of the IgG2<sup>b</sup> allotype.



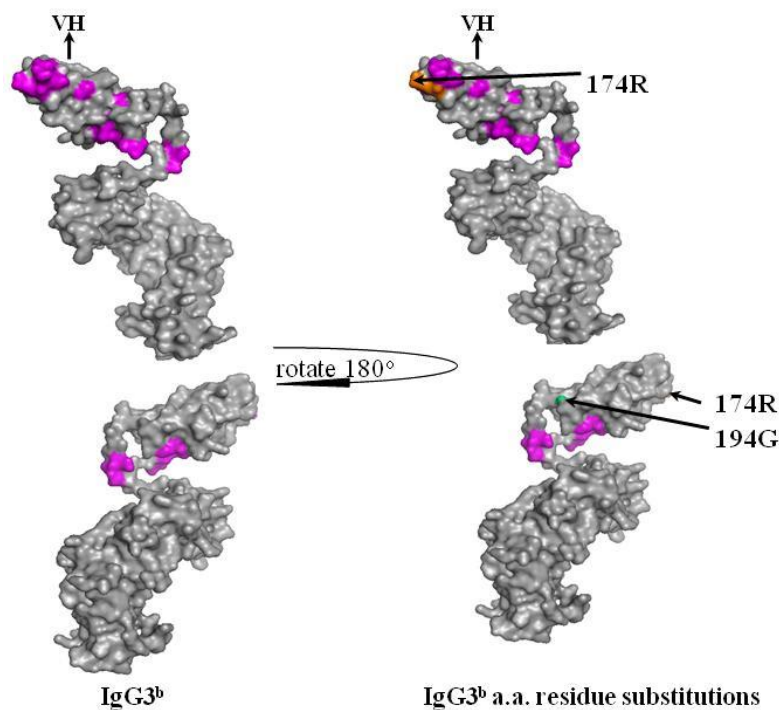
**Fig. 32:** Homology based modeling of isotypes IgG2 allotypic variants of IgG2<sup>b</sup>. Solvent accessible surface views are shown for the predicted 3D structures from two opposite sides. The images at the bottom are turned by 180° over the vertical axis compared to those at the top. The putative interface to CL derived from the crystal structure of the human mAb NEW is magenta. Locations of amino acid (a.a.) residue differences to the basic allotype IgG2<sup>b</sup> within the putative interface are marked in orange, whereas the remaining substitutions are marked in green. VH indicates the location of the corresponding variable region. The description of the amino acid residues corresponds to the Eu index nomenclature.

### 4.1.2.4 Polymorphisms of IgG3<sup>b</sup> allotype in the analyzed cattle breeds

The IgG3 isotype was detected in two homozygous animals, and was distributed as one sequence of one GBP animal and two sequences of one animal of Aubrac. The constant region of these sequences was aligned to Genbank entries U63638\_IgG3<sup>a</sup> and U63639\_IgG3<sup>b</sup> assigning them to allotype IgG3<sup>b</sup>. Four SNPs were detected in the CH1 domain at positions 144, 170, 171, and 230. The SNP144T>C caused a silent mutation at S48, whereas SNPs 170T>G and 171T>G replaced L174 by R174 in the CH1-CL interface causing polarity with negative charge and SNP230A>G substituted E194 by G194 on the outer side with a neutral charge (Fig. 33, 34).

118	A S T T A P K V Y P L A S R C G D T S S S T V T L G C L	145	CH1
1	GCC TCC ACC ACA GCC CCG AAA GTC TAC CCT CTG GCA TCC CGC TGC GGA GAC ACA TCC AGC TCC ACC GTG ACC CTG GGC TGC CTG		U63639_IgG3 <sup>b</sup>
1	...		U63639_IgG3 <sup>b</sup> -SNPs
1	...		U63638_IgG3 <sup>a</sup>
146	V S S Y M P E P V T V T W N S G A L K S G V H T F P A V	173	
85	GTC TCC AGC TAC ATG CCC GAG CCG GTG ACC GTG ACC TGG AAC TCG GGT GCC CTG AAG AGT GGC GTG CAC ACC TTC CCG GCC GTC		U63639_IgG3 <sup>b</sup>
85	...		U63639_IgG3 <sup>b</sup> -SNPs
85	...		U63638_IgG3 <sup>a</sup>
174	L Q S S G L Y S L S S M V T V P A S T S E T Q T F T C N	201	
169	CTT CAG TCC TCC GGG CTG TAC TCT CTC AGC AGT ATG GTG ACC GTG CCC GCC AGC ACC TCA GAA ACC CAG ACC TTC ACC TGC AAC		U63639_IgG3 <sup>b</sup>
169	.GG		U63639_IgG3 <sup>b</sup> -SNPs
169	.GG		U63638_IgG3 <sup>a</sup>
202	V A H P A S S T K V D K A V T A R R K C Q C S K C P E P T T P K T T I	229	CH1 ← Hinge region
253	GTA GCC CAC CCG GCC AGC AGC ACC AAG GTG GAC AAG GCT GTC ACT GCA AGG CGT CCA GTC CCG ACG ACG CCA AAG ACA ACC ATC		U63639_IgG3 <sup>b</sup>
253	...		U63639_IgG3 <sup>b</sup> -SNPs
253	...		U63638_IgG3 <sup>a</sup>
230	P P G K P T T Q E S E V E K T P C Q C S K C P E P T T P K T T I	257	← CH2
337	CCT CCT GGA AAA CCC ACA ACC CAG GAG TCT GAA GTT GAA AAG ACA CCC TGC CAG TGT TCC AAA TGC CCA GAA CCT CTG GGA GGA		U63639_IgG3 <sup>b</sup>
337	...		U63639_IgG3 <sup>b</sup> -SNPs
337	...		U63638_IgG3 <sup>a</sup>
258	L S V F I F P P K P K D T L T I S G T P E V T C V V V D	285	
421	CTG TCT GTC TTC ATC TTC CCA CCG AAA CCC AAG GAC ACC CTC ACA ATC TCG GGA ACG CCC GAG GTC ACG TGT GTG GTG GAC		U63639_IgG3 <sup>b</sup>
421	...		U63639_IgG3 <sup>b</sup> -SNPs
421	...		U63638_IgG3 <sup>a</sup>
286	V G Q D D P E V Q F S W F V D D V E V H T A R T K P R E	313	
505	GTG GGC CAG GAT GAC CCC GAG GTG CAG TTC TCC TGG TTC GTG GAC GAC GTG GAG GTG CAC ACG GCC AGC AGC AAG CCG AGA GAG		U63639_IgG3 <sup>b</sup>
505	...		U63639_IgG3 <sup>b</sup> -SNPs
505	...		U63638_IgG3 <sup>a</sup>
314	E Q F N S T Y R V V S A L R I Q H Q D W L Q G K E F K C	341	
589	GAG CAG TTC AAC AGC ACC TAC CGC GTG GTC AGC GCC CTG CGC ATC CAG CAC GAC TGG CTG CAG GGA AAG GAG TTC AAG TGC		U63639_IgG3 <sup>b</sup>
589	...		U63639_IgG3 <sup>b</sup> -SNPs
589	...		U63638_IgG3 <sup>a</sup>
342	K V N N K G L P A P I V R T I S R T K G Q A R E P Q V Y	369	← CH3
673	AAG GTC AAC AAC AAA GGC CTC CCG GCC CCC ATT GTG AGG ACC ATC TCC AGS ACC AAM GGG CAG GCC CGG GAG CCG CAG GTG TAT		U63639_IgG3 <sup>b</sup>
673	...		U63639_IgG3 <sup>b</sup> -SNPs
673	...		U63638_IgG3 <sup>a</sup>
370	V L A P P R E E L S K S T L S L T C L I T G F Y P E E I	397	
757	GTC CTG GCC CCA CCC CCG GAA GAG CTC AGC AAA AGC ACG CTC AGC CTC ACC TGC CTF ATC ACC GGT TTC TAC CCA GAA GAG ATA		U63639_IgG3 <sup>b</sup>
757	...		U63639_IgG3 <sup>b</sup> -SNPs
757	...		U63638_IgG3 <sup>a</sup>
398	D V E W Q R N G Q P E S E D K Y H T T A P Q L D A D G S	425	
841	GAC GTG GAG TGG CAG AGA AAT GGG CAG CCT GAG TCG GAG GAC AAG TAC CAC ACC ACG GCA CCC CAG CTG GAT GCT GAC GGC TCC		U63639_IgG3 <sup>b</sup>
841	...		U63639_IgG3 <sup>b</sup> -SNPs
841	...		U63638_IgG3 <sup>a</sup>
426	Y F L Y S R L R V N K S S W Q E G D H Y T C A V M H E A	447	
925	TAC TTC CTG TAC AGC AGG CTC AGG GTG AAC AAG AGC AGC TGG CAG GAA GGA GAC CAC TAC ACG TGT GCA GTG ATG CAT GAA GGT		U63639_IgG3 <sup>b</sup>
925	...		U63639_IgG3 <sup>b</sup> -SNPs
925	...		U63638_IgG3 <sup>a</sup>
448	L R N H Y K E K S I S R S P G K	463	
1009	TTA CCG AAT CAC TAC AAA GAG AAG TCC ATC TCG AGG TCT CCG GGT AAA TGA		U63639_IgG3 <sup>b</sup>
1009	...		U63639_IgG3 <sup>b</sup> -SNPs
1009	...		U63638_IgG3 <sup>a</sup>

**Fig. 33:** The nucleotide sequences and amino acid residues of the IgG3 isotype of two cattle breeds (GBP and A) were compared with the sequences of bovine IgG3a (GenBank U63638) and IgG3b (Genbank U63639). The sequences presenting four SNPs to the allele IgG3b, whereas allele IgG3a was not detected in our sequences. Identical nucleotides are indicated with dots (.). The Eu index has been used for numbering. The horizontal numbers indicated to amino acid residues and the vertical numbers indicated to the nucleotide sequences of the IgG3b allotype.



**Fig. 34:** Homology based modeling of allotypic variant IgG3<sup>b</sup> of isotype IgG3. Solvent accessible surface views are shown for the predicted 3D structures from two opposite sides. The images at the bottom are turned by 180° over the vertical axis compared to those at the top. The putative interface to CL derived from the crystal structure of the human mAb NEW is magenta. Locations of amino acid (a.a.) residue differences to the basic allotype IgG3<sup>b</sup> within the putative interface are marked in orange, whereas the remaining substitutions are marked in green. VH indicates the location of the corresponding variable region. The description of the amino acid residues corresponds to the Eu index nomenclature.

## 5 Discussion

The organization of the bovine  $\lambda$ -light chain locus was well analyzed recently (Parng *et al.*, 1995; Sinclair *et al.*, 1995; Chen *et al.*, 2008; Ekman *et al.*, 2009; Pasman *et al.*, 2010). Especially BAC-clone mapping (Chen *et al.*, 2008) and genomic analyses (Ekman *et al.*, 2009; Pasman *et al.*, 2010) led to detailed insights into this dominantly expressed antibody  $\lambda$ -light chain gene. The isolation and characterization of bovine heavy chain genes were performed in the late 1980s (Knight and Becker, 1987; Symons *et al.*, 1987; Knight *et al.*, 1988b; Symons *et al.*, 1989). The bovine IgG isotypes (IgG1, IgG2, and IgG3) and their different allotypes were described (Symons *et al.*, 1989; Kacs Kovics and Butler, 1996; Rabbani *et al.*, 1997; Saini *et al.*, 2007) and give information for the most predominant and expressed IgG isotypes.

Our study is the first detailed genetic description of allotypic variants within the bovine  $\lambda$ -light chain and IgG-heavy chain locus. The data revealed the presence of three allotypic variants of IGLC2 and five allotypic variants of isotype IGLC3, whereas four allotypic variants of IgG1, two allotypic variants of IgG2, and one allotypic variant of IgG3 were presented, in addition to the assumed new allotypic variant IgG1<sup>e</sup>, which were confirmed by homology-based predicted 3D structural analysis.

Regarding the structure control function, the analyses of conserved  $\lambda$ -light and IgG-heavy chain constant regions and their alleles and allotypic variants were performed due to constant region importance in association of light and heavy chain at the CL-CH1, which is important in the VL-VH binding stability, in flexibility of the immunoglobulin molecule (Woof and Burton, 2004) and interacting with other molecules of the immune system, such as Fc-receptor and complement through binding sites that are located on Fc of the constant regions of the molecule, which in turn has an influence on the immune responsiveness and resistance to bacterial and viral infections (Corbeil *et al.*, 1997).

To achieve the detection and analyses of allotypic variants, the total RNA was isolated from B-cells and reverse transcribed into cDNA through the action of the enzyme reverse transcriptase. Since the mRNA amounts to 5 % of the total RNA, this molecule is revealed as more fragile and sensitive than the total RNA, which additionally contains the transfer RNA (tRNA) 15%, and the ribosomale



RNA (rRNA) 80 %, which in turn contribute to its stability (Little *et al.*, 1999; Loset *et al.*, 2005).

The amplification of the  $\lambda$ -light and IgG-heavy chain genes from the synthesized cDNA occurred through the PCR technique using gene specific primers. It was necessary to check the purity and length of the PCR products on agarose gel electrophoresis. Prior to cloning, A-overhang was synthesized allowing attaching with the vector. The sequencing of the selected sixteen clones of both  $\lambda$ -light and IgG-heavy chains were performed using the sequencing primers to give clear and accurate information in the analyses by ClustalW alignment of the constant regions comparable to the known database entries.

We confirmed that two functional isotypes (IGLC2 and IGLC3) of  $\lambda$ -light chain constant regions are expressed in cattle of which IGLC3 was dominantly expressed (Parng *et al.*, 1996; Lucier *et al.*, 1998; Chen *et al.*, 2008; Pasman *et al.*, 2010). IGLC2 isotype showed two new allelic and allotypic forms, which designated as IGLC2<sup>b</sup> and IGLC2<sup>c</sup>. Isotype IGLC3 possessed two new allotypic variants designated as IGLC3<sup>b</sup> and IGLC3<sup>c</sup>. All three described IgG isotypes (IgG1, IgG2, and IgG3) (Symons *et al.*, 1989; Kacs Kovics and Butler, 1996; Rabbani *et al.*, 1997) are presented in our analyzed animals. Regarding the high expression percentage of IgG2, it occurs in two allelic forms and allotypic variants IgG2<sup>a</sup> and IgG2<sup>b</sup> (Blakeslee *et al.*, 1971), followed by IgG1 that possessed previously four known allotypic variants designated as IgG1<sup>a</sup>, IgG1<sup>b</sup>, IgG1<sup>c</sup>, and IgG1<sup>d</sup> (Saini *et al.*, 2007) in addition to assumed allele and allotypic variant IgG1<sup>e</sup> and a very low expression of only allotypic variant IgG3<sup>b</sup> of isotype IgG3 and absence of allotypic variant IgG3<sup>a</sup>.

Today there is no explanation for the observation of predominantly IGLC3 expression in cattle despite the high expression of IgG2 can be explained as it is the most important antibody in neutrophil phagocytosis and antibody-dependent cellular cytotoxicity (ADCC) in cattle and other domestic *Bovidae* and it is better opsonin than IgG1 and in the activation of the complement (Watson, 1976; McGuire *et al.*, 1979; Mossmann *et al.*, 1981). The very low expression of isotype IgG3 might be due to the extended hinge region by 22 amino acids rich in P amino acid, where it consists of 13 amino acids in both IgG1 and IgG2 isotypes, while in IgG3 isotype, hinge region consists of 37 amino acids. This long hinge

region in cattle IgG3 allows greater molecular flexibility of the immunoglobulin and may be more effective in the cross-linking of immune complexes. Additionally, cattle IgG3 may be more susceptible to proteolysis due to its long hinge region, where the hinge region of antibodies is a preferred site for proteolysis and perhaps this causes a low serum concentration of cattle IgG3 and additional glycosylation site (N-X-S) in the CH3 domain that may affect catabolism (Butler *et al.*, 1987; Rabbani *et al.*, 1997). The absence of allotype IgG3<sup>a</sup> may be due to six amino acid substitutions that differ than IgG3<sup>b</sup>, three in the CH1, one in CH3 domains and two in hinge region and 86bp insertion in the interone between the CH2 and CH3 domains (Rabbani *et al.*, 1997).

In  $\lambda$ -light chain constant regions, Isotypes IGLC2<sup>a</sup> and IGLC3<sup>a</sup> differ in eight amino acid residues (Chen *et al.*, 2008; Ekman *et al.*, 2009). Three at positions 11, 79, and 125 represented differences in binding sites to CH1 as determined in the crystal structure of Fabs derived from the human mAbs KOL and NEW (Padlan *et al.*, 1986). These amino acid residues are T11, E79, and G125 in IGLC3 and K11, K79, and A125 in IGLC2. In contrast, bovine IGLC3 differed only at position 11 from the human  $\lambda$ -constant region ensuing a conservative amino acid residue. The substitutions at IGLC2 positions 11, 79, and 125 resulted in charge changes of the side chains. Montano and Morrison (2002) examined the influence of human  $\kappa$ - and  $\lambda$ -light chains in IgG isotypes, respectively, and observed time differences in the assembly of full size antibodies, where  $\lambda$ -light chains can influence the kinetics of intracellular assembly with IgG isotypes more slowly than  $\kappa$ -light chains and influence the susceptibility of the inter-chain disulfide bonds to attack by reducing agents with variable effects, depending on the isotype of the heavy-chain, which has a slight impact on the structural and functional properties of variable region identical antibodies.

Similarly, the IgG-heavy chain constant regions of the two isotypes IgG1 and IgG2 are differed in five amino acid residues in the CH1 domain, eight in the hinge region, thirteen in the CH2 domain and thirteen in the CH3 domain, especially with conservative replacement of the amino acids at position 192 and 356 in the CH1 and CH3 domain, respectively, according to the data shown by (McGuire *et al.*, 1979; Kacsokovics and Butler, 1996). The IgG2 two allotypic variants IgG2<sup>a</sup> and IgG2<sup>b</sup> differ in five amino acid residues in the CH1 domain,

where one of them is at position T192S which is conservative substitution, three in the hinge region, four in the CH2 domain, and seven residues in the CH3 domain (Kacskovics and Butler, 1996).

The comparison between the four described IgG1 allotypic variants (IgG1<sup>a</sup>, IgG1<sup>b</sup>, IgG1<sup>c</sup>, and IgG1<sup>d</sup>) possesses differences in amino acid residues. In the CH1 domain, two amino acid differences were detected at positions 190 and 192, four in the hinge region at position 218, 224, 225, and 226, one in the CH2 and CH3 domain at position 281 and 402, respectively (Saini *et al.*, 2007). Rabbani *et al* (1997) studied the amino acid differences between two allotypic variants of isotype IgG3 that are three in the CH1 domain at positions 131, 174, and 192, two in the hinge region at positions 237 and 238, and one in the CH3 domain at position 431.

To examine the influence of bovine light and heavy chain allotypes on the efficiency of immune response, different genetic variants have to be determined. Allotype IGLC2<sup>c</sup>, which was only detected in one French Aubrac animal, and the new allotype of IgG1 (IgG1<sup>e</sup>) which was detected in only German Simmental breed might also have been found in related breeds and might have been introduced by migration into the breed Aubrac and German Simmental, respectively.

For IGLC3 (Chen *et al.*, 2008) the three out of five allotypes IGLC3<sup>a</sup>, IGLC3<sup>d</sup>, and IGLC3<sup>e</sup> were distinguished by GenBank entries. The new allotype IGLC3<sup>b</sup> was found in all four breeds analyzed in our study, whereas another new allotype, named IGLC3<sup>c</sup>, was only found in Aubrac and German Simmental. Additional analyses of the bovine ESTs database disclosed 100% coverage and identity of the allotype IGLC3<sup>a</sup> constant region in the breeds Hereford and Angus, while IGLC3<sup>b</sup> was only found in Angus. Furthermore, IGLC3<sup>c</sup> was detected in Holstein Friesian and Holstein Friesian crossbreeds, whereas IGLC3<sup>d</sup> was found in Angus- and Holstein Friesian crossbreed and Hereford.

IGLC3<sup>b</sup> was not detected in the bovine ESTs database by Pasman *et al.* (2010), because their identity threshold was set at  $\geq 99\%$ . Similarity between IGLC3<sup>a</sup> and IGLC3<sup>b</sup> was only 96% considering the joining segment and the C-terminal amino acid residue motif PSEC as definition for IGLC3. IGLC2<sup>a</sup> were found in ESTs of Angus, Holstein Friesian, and Hereford, whereas IGLC2<sup>b</sup> and

IGLC2<sup>c</sup> did not have any comparable nucleotide sequences within the ESTs database. In the IgG2 isotype, the allotypic variant IgG2<sup>a</sup> is the most expressed one of the high expressed IgG2 isotype among our analyzed breeds as mentioned by Kacskovics *et al.* (1995), whereas the allotypic variants IgG1<sup>a</sup> and IgG1<sup>d</sup> were the most expressed for isotype IgG1. We suggest the designation of IGLC3<sup>a</sup>, IGLC3<sup>b</sup>, IgG2<sup>a</sup>, IgG2<sup>b</sup>, IgG1<sup>a</sup>, and IgG1<sup>d</sup> as major allotypes, because they have been found in many individual animals during our investigation.

Evolutionary selection pressure or breeding practices might be the reason for the dominant occurrence of the allotypes IGLC3<sup>a</sup>, IGLC3<sup>b</sup>, IgG2<sup>a</sup>, IgG2<sup>b</sup>, IgG1<sup>a</sup>, and IgG1<sup>d</sup> in most of examined breeds. The diverse evolution of a number of minor allotypes, e.g. IGLC2<sup>c</sup> and IgG1<sup>e</sup>, could have an advantage to the immune response of local breeds, especially in the defense against endemic pathogens. Furthermore, specific allotypes might be conserved in small populations, but, as in the case of German Black Pied, only the major allotypes IGLC3<sup>a</sup>, IGLC3<sup>b</sup>, IgG2<sup>a</sup>, IgG1<sup>a</sup>, and IgG1<sup>d</sup> were detected and IgG2<sup>b</sup> was absent. Although the non major allotypes IgG1<sup>b</sup> and IgG3<sup>b</sup> were absent in German Simmental, they were detected in German Black Pied, whereas IgG1<sup>c</sup> was detected only in Holstein Friesian with lower expression than other IgG1 allotypes.

The major and minor allotypes were found in Aubrac except allotype IgG1<sup>d</sup>. All the examined breeds possessed high IgG2<sup>a</sup> as immunodominant allotype such as HF, it shows higher expression of IgG2<sup>a</sup> than IgG2<sup>b</sup> as detected by Kacskovics & Butler (1996) in HF during four weeks before calving, whereas it is known that IgG2<sup>b</sup> activates the complement better than IgG2<sup>a</sup> due to its rigid hinge region or additional interchain disulfide bond at position 224 in hinge region (Bastida-Corcuera *et al.*, 1999a).

It was shown that both allotypes IgG2<sup>a</sup> and IgG2<sup>b</sup> bound equally to *Staphylococcus aureus* protein A (PrA) and streptococcal protein G (PrG) (Bastida-Corcuera *et al.*, 1999b) because three PrA and four PrG contact sites in IgG2 Fc region (Sauer-Eriksson *et al.*, 1995) have the same amino acids in both allotypes (Kacskovics and Butler, 1996). In contrast, *Haemophilus somnus* high molecular weight immunoglobulin binding proteins (HMW IgBPs) bound to IgG2<sup>b</sup> and do not bind IgG2<sup>a</sup> where its Fc binding site on IgG2<sup>a</sup> has different

amino acid sequence led to better ability of IgG2<sup>a</sup> to mediate complement killing of *Haemophilus somnus* (Bastida-Corcuera *et al.*, 1999a). IgG2<sup>a</sup> and IgG2<sup>b</sup> are different than each other in the hinge and CH2 domain amino acid sequences which may be the reason for their different behavior. Both IgG2<sup>a</sup> and IgG2<sup>b</sup> have the same structure of CH1 and CH3 domains such in IgG1, where IgG2<sup>b</sup> might represent conversion of a pseudogene (Kacskovics *et al.*, 1995). It can be predicted that German Black Pied has better immunoresponse than the other three breeds, where it possessed only allotypic variant IgG2<sup>a</sup> of isotype IgG2.

For allotype IGLC3<sup>b</sup> a less frequent occurrence was calculated. Only a small number of 2438 animals including 8 bulls were registered in the German Black Pied herdbook in 2009 (Arbeitsgemeinschaft Deutscher Rinderzüchter e.V. and ADR.). In general, in small populations an increasing inbreeding and loss of alleles through variable population sizes (bottleneck effect) can lead to genetic drift and homogenization of genetic information (Constans *et al.*, 1985; Simianer and Kohn, 2010). However, we cannot exclude a close kinship of the sampled animals. Future studies should evaluate how allotypic markers of heavy and light chains are distributed in different cattle breeds and how they are linked to infectious diseases, which might allow the development of generations of resistant as well as highly productive breeds by crossbreeding.

The transition in positions 129 of IgG2<sup>a</sup>, 190 of IgG2<sup>b</sup> and IgG1<sup>a</sup>, 139 of IgG1<sup>a</sup> and IgG1<sup>c</sup>, and 174 of IgG3<sup>b</sup> of the CH1 domain was located in the CH1-CL interface. In IgG2<sup>b</sup>, amino acid residue substitution at position 434 is located in the CH3-CH3 interface in comparison to human amino acid residues in the CH3-CH3 interface that exist at positions 433–436 of the CH3 domain (Junghans, 1997; Ghetie and Ward, 2000). These amino acid residue substitutions led to change of the polarity at positions 139, 174, and 434 leaving positive charge at position 174.

Amino acid differences in the assumed new allotypic variant IgG1<sup>c</sup> were detected in the CH1, CH2, and CH3 domains and hinge region at positions 139, 222, 223, 318 and 340. Amino acid residues S222 and P223 were replaced by L and R causing polarity and positive charge. These changes in the structure may alter the flexibility for Fab region to Fc region and regulate effector functions (Oi, 1984), in addition to susceptible to proteolytic cleavage (Saini *et al.*, 2007). These

findings are primary and they need further investigations.

Only one motif (PASS, 205-208) was found in the assumed allotypic variant IgG1<sup>e</sup> like the other known allotypes except IgG1<sup>c</sup> which contains two motifs (189-192 and 205-208) (Saini *et al.*, 2007). In our analysis, the first motif (189-192) of IgG1<sup>e</sup> and IgG1<sup>b</sup> was differed than IgG1<sup>c</sup>, where it consisted of PGSS instead of known PASS. The replacement of amino acid residue A with G did not possess structural effect due to short side chain of G. Regarding this, we suggested that it could be have the same effect as IgG1<sup>c</sup> in stabilizing the core immunoglobulin fold where it acts as connector for core  $\beta$ -sheets (E/F and F/G) of the CH1 domain and form a part of a single turn  $3_{10}$ -helix, promote interaction with fibronectin receptors or similar adhesion molecules and have a role in cellular adhesion and migration (Saini *et al.*, 2007). On the other hand, the amino acid substitution at positions 190 and 192 of allotypic variant IgG1<sup>a</sup> changed the amino acid G190A and T192S, which led to change in the first motif (189-192) from PGST to PASS causing the same two motifs as found in IgG1<sup>c</sup>, which was absent in the database entry of allotype IgG1<sup>a</sup>. We suggested also that tetrapeptide form could function as structure-enhancing elements (Rowe, 1976). The very low expression of IgG1c may refer to two R residues in the hinge region, which may be more susceptible for immune evasion by protease-producing bacteria (Saini *et al.*, 2007).

The polar amino acid T195 was absent from CH1 region of IgG1<sup>a</sup>, IgG1<sup>b</sup>, IgG1<sup>d</sup>, IgG1<sup>e</sup>, and IgG2<sup>a</sup> clone 32.2.8, whereas it was present in the original sequences of IgG1<sup>a</sup> and IgG1<sup>c</sup>. These results led to the assumption of a structural influence, the constant region of the heavy chain and the light chain in human influence whole molecule assembly, clearance, and affinity of antigen binding (Pritsch *et al.*, 2000; Montano and Morrison, 2002). The constant regions are responsible for maintaining the association of the chains in addition to the variable region, which contributes significantly to the association of the chains by its connection to the associated constant region.

Four cysteine (C) residues in the CH1 domain at positions 131, 132, 144, and 200 in IgG1 and IgG2<sup>a</sup> allotypes were observed in our breeds, which were identical to the results in cattle and goat (Strausbach PH, 1971; Symons *et al.*, 1989), while there were three only at positions 132, 144, and 200 of IgG2<sup>b</sup> and

IgG3. Saini *et al* (2007) mentioned that C131 may involve in inter-chain disulfide with light chain, whereas C144 and 200 may form intra-chain disulfide. In case of C132, its side chain is predicted to be in close proximity to C221 in the hinge region, which may form an additional disulfide linkage that reduces the flexibility of cattle IgG1 antibodies. In contrast to IgG2<sup>b</sup> and IgG3, also C132 may be involved in inter-chain disulfide with light chain in absence of C131.

The presence of the CH2 and CH3 substitutions in both IgG1 and IgG2 may affect the CH2-CH3 interface of IgG which participates in binding Fc $\gamma$ Rs (Ades *et al.*, 1976) and serological differences and bacterial Ig-binding protein which may be related to the sequences at the beginning or at the end of intradomain disulfide loop in the CH3 domain (Kacs Kovics and Butler, 1996), as it was described by ((Burmeister *et al.*, 1994) that FcRs are bound to Fc at the interface between the CH2 and CH3 domains. Especially, the second constant domain CH2 plays a very important role in the complement activation and forms the binding site for C1q (Leatherbarrow *et al.*, 1985; Tao *et al.*, 1991; Idusogie *et al.*, 2000) at positions E319, K321, and K323 (Bastida-Corcuera *et al.*, 1999a). In all IgG1 allotypic variants, conserved amino acid residues were detected at positions D270, K322, P329, and P331, which are known for close 3D proximity and constitute the core C1q-binding residues in human (Yoo *et al.*, 2002).

The authors also discovered differences in *in vivo* clearance and in the kinetics of antigen binding. In the reverse case CH1 regions of human Fabs derived from isotypes IgA1 and IgG1 as well as the whole heavy chain isotypes were related to antibody affinity (Pritsch *et al.*, 1996; Pritsch *et al.*, 2000). These data showed that the isotypes of heavy and light chains play a role in antibody functionality but the changing of the isotype of the light-chain does not have any effect on the conformation of the CH2-CH3 interface (Montano and Morrison, 2002).

In conclusion, the analyses of  $\lambda$ -light chain and IgG-heavy chain constant regions in cattle breeds German Black Pied (GBP), German Simmental (GS), Holstein Friesian (HF), Aubrac (A), three transcribed allotypic variants in isotype IGLC2, five allotypic variants in isotype IGLC3, five allotypic variants in isotype IgG1, two allotypic variants in isotype IgG2, and one allotypic variant in isotype IgG3 were identified and absence of allotypic variant IgG3<sup>a</sup>. Amino acid residue

substitutions located at the outer side and within the accessible surface area might be distinguished by specific sera and, consequently, might be used as markers. In the past specific markers that differed in frequencies within human populations had already been found in  $\kappa$ - and  $\lambda$ -light chains as well as in heavy chains (Matsumoto *et al.*, 1984; Calderon *et al.*, 2007; Schanfield *et al.*, 2008). Allotypic markers of human light and heavy chains were related to susceptibility of different infectious diseases due to either a direct association or linkage disequilibrium with the causative gene (Pandey *et al.*, 1979; Granoff *et al.*, 1984; Pandey *et al.*, 1995; Pandey, 2000; Giha *et al.*, 2009). Allotypic changes in bovine  $\gamma 2$ -constant regions influenced the effector function of the antibody molecule as previously estimated for infections with *Haemophilus somnus* and *Tritrichomonas foetus* (Corbeil *et al.*, 1997; Bastida-Corcuera *et al.*, 1999b; Bastida-Corcuera *et al.*, 2000). In addition, differences were observed in complement activation and age related expression (Corbeil *et al.*, 1997; Bastida-Corcuera *et al.*, 1999a; Bastida-Corcuera *et al.*, 1999b). The analysis of bovine IgG1 allotypic variants indicated differences in cellular adhesion and migration of the corresponding immunoglobulin molecules as well as different susceptibilities to degradation by bacterial proteases (Saini *et al.*, 2007). Consequently, heterozygotic individuals may have advantages to the humoral immune response. Future studies should evaluate how allotypic markers of heavy and light chains are distributed in different cattle breeds and how they are linked to infectious diseases, which might allow the development of generations of resistant as well as highly productive breeds by crossbreeding.



## 6 Summary

In cattle, immunogenetics needs more investigations, where it did not give complete information about the available number of gene segments, gene families of different isotypes of heavy and light chains or their allotypes. The identification of different alleles and allotypic variants heavy chains and light chains constant regions is very important due to their importance in interacting with other molecules of the immune system, such as Fc-receptors and the complement through binding sites that are located on the constant (C) domains of the molecule. Regarding this, it influences the immune responsiveness and resistance to bacterial and viral infections. It can be used in the creation of recombinant antibody that replaced the use of animals in creation of antibodies.

This study was done to investigate the comparative analyses of bovine IGLC and IgG heavy-chain constant region sequences of four cattle breeds (German Black Pied, German Simmental, Holstein Friesian, and Aubrac) with different population sizes, distribution areas and investigated the identification of different alleles and allotypic variants. Using comparative 3D modeling with known crystal structures, variable allotypic locations of amino acid residue substitutions within the molecule were examined. Their putative influence within the molecule was discussed. We based our analyses of IGLC on the findings of Chen *et al.* (2008) because the complete IGLJ-IGLC cluster from Holstein cattle breed has been sequenced and annotated, whereas we compared the sequences of IgG isotypes to Saini *et al.* (2007), Rabbani *et al.* (1997), Kacs Kovics and Butler (1996).

In the first investigation, three transcribed allotypic variants in isotype IGLC2 and five allotypic variants in isotype IGLC3 were identified. Substitutions within the putative interface to CH1 at position 11 and 79 were noted. In IGLC2<sup>b</sup>, K79E led to a charge conversion. In IGLC3<sup>b</sup> and IGLC3<sup>c</sup>, the E79N replacement removed the charge while the T11K substitution resulted in a positively charged amino acid residue. In addition, D15 and T16 were found in IGLC2<sup>c</sup>, IGLC3<sup>b</sup>, and IGLC3<sup>c</sup>. Substitutions located on the outer site of the molecule were observed in IGLC2<sup>b</sup> (V40, H45.5), IGLC2<sup>c</sup> (A1, V40, D77), IGLC3<sup>b</sup> (A1, D77, D109, P127), IGLC3<sup>c</sup> (A1, G45.5, D77, D109, P127), IGLC3<sup>d</sup> (D109), and IGLC3<sup>e</sup> (A1). Amino acid residues P83 (IGLC2<sup>c</sup>, IGLC3<sup>b</sup>, IGLC3<sup>c</sup>), N93 (IGLC2<sup>b</sup>), D93

(IGLC3<sup>b</sup>), and G93 (IGLC3<sup>c</sup>) were positioned in cavities but seemed to be accessible for solvents.

In the second investigation, five transcribed allotypic variants in isotype IgG1, two allotypic variants in isotype IgG2 and one allotypic variant in isotype IgG3 were identified. Substitutions within the putative interface to CL at position 129, 139, 174, and 190 were noted. Substitution at position L174R of IgG3<sup>b</sup> led to charge conversion and polarity, while T139G of IgG1<sup>a</sup> and IgG1<sup>c</sup> led to polarity conversion only. The isotype IgG2 was the most expressed isotype with preferential expression to allotypic variant IgG2<sup>a</sup>, followed by Isotype IgG1 and one allotypic variant (IgG3<sup>b</sup>) of IgG3 was expressed in a very low percentage. In the assumed allotypic variant IgG1<sup>c</sup>, two substitutions at position S222L and P223R of hinge region were observed and led to change polarity. Substitution at position T251K of IgG2<sup>a</sup>, K318T, and P340Q of IgG1<sup>c</sup> were located in the inner surface of the CH2 domain. Amino acid residues T251K and K318T cause charge change, whereas P340Q change the polarity. Amino acids at positions R397S, M434T of IgG2<sup>b</sup>, and A445P of IgG1<sup>a</sup> located in the CH3 domain. Substitution at position R397S alter the charge, while M434T changes the polarity and located in CH3-CH3 interface. The assumed new allotypic variant IgG1<sup>c</sup> possesses one motif (PASS) at positions (205-208) as detected in the three IgG1 allotypes (IgG1<sup>a</sup>, IgG1<sup>b</sup>, and IgG1<sup>d</sup>) except IgG1<sup>c</sup> which possessed two motifs (PASS) at positions (189-192) and (205-208). Furthermore, IgG1<sup>c</sup> contains PGSS motif at positions (189-192) which may play the same role as the first motif of IgG1<sup>c</sup>.

It could be concluded from this study that amino acid residue substitutions located at the outer side and within the accessible surface area might be distinguished by specific sera and, consequently, might be used as markers. Allotypic changes in bovine IgG constant regions influenced the effector function of the antibody molecule and give different susceptibilities to degradation by bacterial proteases. Consequently, heterozygotic individuals may have advantages to the humoral immune response.

## 7 Bibliography

Ades, E.W., Phillips, D.J., Shore, S.L., Gordon, D.S., LaVia, M.G., Black, C.M., Reimer, C.B., 1976. Analysis of mononuclear cell surfaces with fluoresceinated staphylococcal protein A complexed with IgG antibody of heat-aggregated gamma-globulin. *J Immunol* 117, 2119-2123.

Aitken, R., Hosseini, A., MacDuff, R., 1999. Structure and diversification of the bovine immunoglobulin repertoire. *Vet Immunol Immunopathol* 72, 21-29.

Allen, J.M., Seed, B., 1989. Isolation and expression of functional high-affinity Fc receptor complementary DNAs. *Science* 243, 378-381.

Arakawa, H., Buerstedde, J.M., 2009. Activation-induced cytidine deaminase-mediated hypermutation in the DT40 cell line. *Philos Trans R Soc Lond B Biol Sci* 364, 639-644.

Arakawa, H., Saribasak, H., Buerstedde, J.M., 2004. Activation-induced cytidine deaminase initiates immunoglobulin gene conversion and hypermutation by a common intermediate. *PLoS Biol* 2, E179.

Arbeitsgemeinschaft Deutscher Rinderzüchter e.V., ADR., Zucht, Leistungsprüfungen, Besamung. Arbeitsgemeinschaft Deutscher Rinderzüchter e.V., Bonn.

Armour, K.L., Tempest, P.R., Fawcett, P.H., Fernie, M.L., King, S.I., White, P., Taylor, G., Harris, W.J., 1994. Sequences of heavy and light chain variable regions from four bovine immunoglobulins. *Mol Immunol* 31, 1369-1372.

Arun, S.S., Breuer, W., Hermanns, W., 1996. Immunohistochemical examination of light-chain expression (lambda/kappa ratio) in canine, feline, equine, bovine and porcine plasma cells. *Zentralbl Veterinarmed A* 43, 573-576.

Bastida-Corcuera, F., Butler, J.E., Heyermann, H., Thomford, J.W., Corbeil, L.B., 2000. Tritrichomonas foetus extracellular cysteine proteinase cleavage of bovine IgG2 allotypes. *J Parasitol* 86, 328-332.

Bastida-Corcuera, F.D., Butler, J.E., Yahiro, S., Corbeil, L.B., 1999a. Differential complement activation by bovine IgG2 allotypes. *Vet Immunol Immunopathol* 71, 115-123.

Bastida-Corcuera, F.D., Nielsen, K.H., Corbeil, L.B., 1999b. Binding of bovine IgG2a and IgG2b allotypes to protein A, protein G, and Haemophilus somnus IgBPs. *Vet Immunol Immunopathol* 71, 143-149.

Berens, S.J., Wylie, D.E., Lopez, O.J., 1997. Use of a single VH family and long CDR3s in the variable region of cattle Ig heavy chains. *Int Immunol* 9, 189-199.

Bergman, Y., Cedar, H., 2004. A stepwise epigenetic process controls immunoglobulin allelic exclusion. *Nat Rev Immunol* 4, 753-761.

Blakeslee, D., Rapacz, J., Butler, J.E., 1971. Bovine immunoglobulin allotypes. *J Dairy Sci* 54, 1319-1320.

Bransteitter, R., Pham, P., Scharff, M.D., Goodman, M.F., 2003. Activation-induced cytidine deaminase deaminates deoxycytidine on single-stranded DNA but requires the action of RNase. *Proc Natl Acad Sci U S A* 100, 4102-4107.

Broad, T.E., Burkin, D.J., Cambridge, L.M., Jones, C., Lewis, P.E., Morse, H.G., Geyer, D., Pearce, P.D., Ansari, H.A., Maher, D.W., 1995. Six loci mapped on to human chromosome 2p are assigned to sheep chromosome 3p. *Anim Genet* 26, 85-90.

Brown, W.R., Rabbani, H., Butler, J.E., Hammarstrom, L., 1997. Characterization of the bovine C alpha gene. *Immunology* 91, 1-6.

Burg, N.D., Pillinger, M.H., 2001. The neutrophil: function and regulation in innate and humoral immunity. *Clin Immunol* 99, 7-17.

Burmeister, W.P., Gastinel, L.N., Simister, N.E., Blum, M.L., Bjorkman, P.J., 1994. Crystal structure at 2.2 Å resolution of the MHC-related neonatal Fc receptor. *Nature* 372, 336-343.

Butler, J., 1995. Antigen receptors, their immunomodulation and the immunoglobulin genes of cattle and swine. *Livest Prod Sci* 42, 105-121.

Butler, J.E., 1997. Immunoglobulin gene organization and the mechanism of repertoire development. *Scand J Immunol* 45, 455-462.

Butler, J.E., Heyermann, H., Frenyo, L.V., Kiernan, J., 1987. The heterogeneity of bovine IgG2. II. The identification of IgG2b. *Immunol Lett* 16, 31-38.

Calderon, Y., Haughey, M., Leider, J., Bijur, P.E., Gennis, P., Bauman, L.J., 2007. Increasing willingness to be tested for human immunodeficiency virus in the emergency department during off-hour tours: a randomized trial. *Sex Transm Dis* 34, 1025-1029.

Cartron, G., Dacheux, L., Salles, G., Solal-Celigny, P., Bardos, P., Colombat, P., Watier, H., 2002. Therapeutic activity of humanized anti-CD20 monoclonal antibody and polymorphism in IgG Fc receptor FcγRIIIa gene. *Blood* 99, 754-758.

Casswall, T.H., Nilsson, H.O., Bjorck, L., Sjostedt, S., Xu, L., Nord, C.K., Boren, T., Wadstrom, T., Hammarstrom, L., 2002. Bovine anti-*Helicobacter pylori* antibodies for oral immunotherapy. *Scand J Gastroenterol* 37, 1380-1385.

Chaudhuri, J., Tian, M., Khuong, C., Chua, K., Pinaud, E., Alt, F.W., 2003. Transcription-targeted DNA deamination by the AID antibody diversification enzyme. *Nature* 422, 726-730.

Chen, L., Li, M., Li, Q., Yang, X., An, X., Chen, Y., 2008. Characterization of the bovine immunoglobulin lambda light chain constant IGLC genes. *Vet Immunol Immunopathol* 124, 284-294.

Chowdhary, B.P., Fronicke, L., Gustavsson, I., Scherthan, H., 1996. Comparative analysis of the cattle and human genomes: detection of ZOO-FISH and gene mapping-based chromosomal homologies. *Mamm Genome* 7, 297-302.

Clarkson, C.A., Beale, D., Coadwell, J.W., Symons, D.B., 1993. Sequence of ovine Ig gamma 2 constant region heavy chain cDNA and molecular modelling of ruminant IgG isotypes. *Mol Immunol* 30, 1195-1204.

Clynes, R.A., Towers, T.L., Presta, L.G., Ravetch, J.V., 2000. Inhibitory Fc receptors modulate in vivo cytotoxicity against tumor targets. *Nat Med* 6, 443-446.

Constans, J., Hazout, S., Garruto, R.M., Gajdusek, D.C., Spees, E.K., 1985. Population distribution of the human vitamin D binding protein: anthropological considerations. *Am J Phys Anthropol* 68, 107-122.

Corbeil, L.B., 2002. Antibodies as effectors. *Vet Immunol Immunopathol* 87, 169-175.

Corbeil, L.B., Gogolewski, R.P., Kacskovics, I., Nielsen, K.H., Corbeil, R.R., Morrill, J.L., Greenwood, R., Butler, J.E., 1997. Bovine IgG2a antibodies to *Haemophilus somnus* and allotype expression. *Can J Vet Res* 61, 207-213.

Das, S., Nikolaidis, N., Klein, J., Nei, M., 2008. Evolutionary redefinition of immunoglobulin light chain isotypes in tetrapods using molecular markers. *Proc Natl Acad Sci U S A* 105, 16647-16652.

Di Gaetano N, C.E., Nota R, et al, 2003. Complement activation determines the therapeutic activity of rituximab in vivo. *J Immunol* 171, 1581–1587.

Di Noia, J., Neuberger, M.S., 2002. Altering the pathway of immunoglobulin hypermutation by inhibiting uracil-DNA glycosylase. *Nature* 419, 43-48.

Dübel, 2007. *Handbook of therapeutic antibodies* Weinheim: Willey-VCH.

Ekman, A., Niku, M., Liljavirta, J., Iivanainen, A., 2009. *Bos taurus* genome sequence reveals the assortment of immunoglobulin and surrogate light chain genes in domestic cattle. *BMC Immunol* 10, 22.

Emorine, L., Dreher, K., Kindt, T.J., Max, E.E., 1983. Rabbit immunoglobulin kappa genes: structure of a germline b4 allotype J-C locus and evidence for several b4-related sequences in the rabbit genome. *Proc Natl Acad Sci U S A* 80, 5709-5713.

Faber, C., Shan, L., Fan, Z., Guddat, L.W., Furebring, C., Ohlin, M., Borrebaeck, C.A., Edmundson, A.B., 1998. Three-dimensional structure of a human Fab with high affinity for tetanus toxoid. *Immunotechnology* 3, 253-270.

Foley, R.C., Beh, K.J., 1992. Analysis of immunoglobulin light chain loci in sheep. *Anim Genet* 23, 31-42.

Ford, J.E., Home, W.A., Gibson, D.M., 1994. Light chain isotype regulation in the horse. Characterization of Ig kappa genes. *J Immunol* 153, 1099-1111.

Fraenkel, S., Mostoslavsky, R., Novobrantseva, T.I., Pelanda, R., Chaudhuri, J., Esposito, G., Jung, S., Alt, F.W., Rajewsky, K., Cedar, H., Bergman, Y., 2007. Allelic 'choice' governs somatic hypermutation in vivo at the immunoglobulin kappa-chain locus. *Nat Immunol* 8, 715-722.

Ghetie, V., Ward, E.S., 2000. Multiple roles for the major histocompatibility complex class I-related receptor FcRn. *Annu Rev Immunol* 18, 739-766.

Giha, H.A., Nasr, A., Iriemenam, N.C., Arnot, D., Troye-Blomberg, M., Theander, T.G., Berzins, K., ElGhazali, G., Pandey, J.P., 2009. Antigen-specific influence of GM/KM allotypes on IgG isotypes and association of GM allotypes with susceptibility to *Plasmodium falciparum* malaria. *Malar J* 8, 306.

Granoff, D.M., Pandey, J.P., Boies, E., Squires, J., Munson, R.S., Jr., Suarez, B., 1984. Response to immunization with *Haemophilus influenzae* type b polysaccharide-pertussis vaccine and risk of *Haemophilus meningitis* in children with the Km(1) immunoglobulin allotype. *J Clin Invest* 74, 1708-1714.

Griebel, P.J., Ferrari, G., 1994. Evidence for a stromal cell-dependent, self-renewing B cell population in lymphoid follicles of the ileal Peyer's patch of sheep. *Eur J Immunol* 24, 401-409.

Grubb, R., 1995. Advances in human immunoglobulin allotypes. *Exp Clin Immunogenet* 12, 191-197.

Gu, F., Chowdhary, B.P., Andersson, L., Harbitz, I., Gustavsson, I., 1992. Assignment of the bovine immunoglobulin gamma heavy chain (IGHG) gene to chromosome 21q24 by in situ hybridization. *Hereditas* 117, 237-240.

Hamers-Casterman, C., Atarhouch, T., Muyldermans, S., Robinson, G., Hamers, C., Songa, E.B., Bendahman, N., Hamers, R., 1993. Naturally occurring antibodies devoid of light chains. *Nature* 363, 446-448.

Hammarstrom, L., Gardulf, A., Hammarstrom, V., Janson, A., Lindberg, K., Smith, C.I., 1994. Systemic and topical immunoglobulin treatment in immunocompromised patients. *Immunol Rev* 139, 43-70.

Haque, B., 1992. PhD thesis. Sequence analysis of bovine lambda light chain and Mu heavy chain genes: evolutionary implications. University of Massachusetts USA.



Hein, W.R., Dudler, L., 1998. Diversity of Ig light chain variable region gene expression in fetal lambs. *Int Immunol* 10, 1251-1259.

Hohlfeld, R., Wekerle, H., 2005. Drug insight: using monoclonal antibodies to treat multiple sclerosis. *Nat Clin Pract Neurol* 1, 34-44.

Home, W.A., Ford, J.E., Gibson, D.M., 1992. L chain isotype regulation in horse. I. Characterization of Ig lambda genes. *J Immunol* 149, 3927-3936.

Hust, M., Dubel, S., 2004. Mating antibody phage display with proteomics. *Trends Biotechnol* 22, 8-14.

Hust, M., Maiss, E., Jacobsen, H.J., Reinard, T., 2002. The production of a genus-specific recombinant antibody (scFv) using a recombinant potyvirus protease. *J Virol Methods* 106, 225-233.

Idusogie, E.E., Presta, L.G., Gazzano-Santoro, H., Totpal, K., Wong, P.Y., Ultsch, M., Meng, Y.G., Mulkerrin, M.G., 2000. Mapping of the C1q binding site on rituxan, a chimeric antibody with a human IgG1 Fc. *J Immunol* 164, 4178-4184.

Jackson, S.M., Osborne, B.A., Goldsby, R.A., 1996. Diversification of immunoglobulin VH genes in individual follicles of bovine IPP. *FASEB J* 10, 1031.

Jackson, T., Morris, B.A., Sanders, P.G., 1992. Nucleotide sequences and expression of cDNAs for a bovine anti-testosterone monoclonal IgG1 antibody. *Mol Immunol* 29, 667-676.

Jackson, D.A., Symons, R.H., Berg, P., 1972. Biochemical method for inserting new genetic information into DNA of Simian Virus 40: circular SV40 DNA molecules containing lambda phage genes and the galactose operon of *Escherichia coli*. *Proc Natl Acad Sci U S A* 69, 2904-2909.

Janeway, C., 2001. Immunobiology 5 the immune system in health and disease. Garland Pub., New York.

Janeway, C.A., Travers, P., 1997. Immunobiology : the immune system in health and disease. Current Biology ; Garland Pub., London ; San Francisco New York.

Jenne, C.N., Kennedy, L.J., McCullagh, P., Reynolds, J.D., 2003. A new model of sheep Ig diversification: shifting the emphasis toward combinatorial mechanisms and away from hypermutation. *J Immunol* 170, 3739-3750.

Junghans, R.P., 1997. Finally! The Brambell receptor (FcRB). Mediator of transmission of immunity and protection from catabolism for IgG. *Immunol Res* 16, 29-57.

Kacs Kovics, I., 2004. Fc receptors in livestock species. *Vet Immunol Immunopathol* 102, 351-362.

Kacs Kovics, I., Butler, J.E., 1996. The heterogeneity of bovine IgG2--VIII. The complete cDNA sequence of bovine IgG2a (A2) and an IgG1. *Mol Immunol* 33, 189-195.

Kacs Kovics, I., Wittum, T.E., Butler, J.E., Littledike, E.T., 1995. The heterogeneity of bovine IgG2. VII. The phenotypic distribution of the A1 and A2 allotypes of IgG2a among beef cows with known clinical history. *Vet Immunol Immunopathol* 48, 89-96.

Kameda, H., Pandey, J.P., Kaburaki, J., Inoko, H., Kuwana, M., 1998. Immunoglobulin allotype gene polymorphisms in systemic sclerosis: interactive effect of MHC class II and KM genes on anticentromere antibody production. *Ann Rheum Dis* 57, 366-370.

Kaushik, A.K., Kehrl, M.E., Jr., Kurtz, A., Ng, S., Koti, M., Shojaei, F., Saini, S.S., 2009. Somatic hypermutations and isotype restricted exceptionally long

CDR3H contribute to antibody diversification in cattle. *Vet Immunol Immunopathol* 127, 106-113.

Kaushik, A., Shojaei, F., Saini, S.S., 2002. Novel insight into antibody diversification from cattle. *Vet Immunol Immunopathol* 87, 347-350.

Kelley, L.A., Sternberg, M.J., 2009. Protein structure prediction on the Web: a case study using the Phyre server. *Nat Protoc* 4, 363-371.

Kennedy, A.D., Beum, P.V., Solga, M.D., DiLillo, D.J., Lindorfer, M.A., Hess, C.E., Densmore, J.J., Williams, M.E., Taylor, R.P., 2004. Rituximab infusion promotes rapid complement depletion and acute CD20 loss in chronic lymphocytic leukemia. *J Immunol* 172, 3280-3288.

Knight, J., Zenke, M., Disela, C., Kowenz, E., Vogt, P., Engel, J.D., Hayman, M.J., Beug, H., 1988a. Temperature-sensitive v-sea transformed erythroblasts: a model system to study gene expression during erythroid differentiation. *Genes Dev* 2, 247-258.

Knight, K.L., Suter, M., Becker, R.S., 1988b. Genetic engineering of bovine Ig. Construction and characterization of hapten-binding bovine/murine chimeric IgE, IgA, IgG1, IgG2, and IgG3 molecules. *J Immunol* 140, 3654-3659.

Knight, K.L., Becker, R.S., 1987. Isolation of genes encoding bovine IgM, IgG, IgA and IgE chains. *Vet Immunol Immunopathol* 17, 17-24.

Korhonen, H., Marnila, P., Gill, H.S., 2000. Bovine milk antibodies for health. *Br J Nutr* 84 Suppl 1, S135-146.

Kratzin, H.D., Palm, W., Stangel, M., Schmidt, W.E., Friedrich, J., Hilschmann, N., 1989. [The primary structure of crystallizable monoclonal immunoglobulin IgG1 Kol. II. Amino acid sequence of the L-chain, gamma-type, subgroup I]. *Biol Chem Hoppe Seyler* 370, 263-272.

Leatherbarrow, R.J., Rademacher, T.W., Dwek, R.A., Woof, J.M., Clark, A., Burton, D.R., Richardson, N., Feinstein, A., 1985. Effector functions of a monoclonal aglycosylated mouse IgG2a: binding and activation of complement component C1 and interaction with human monocyte Fc receptor. *Mol Immunol* 22, 407-415.

Lee, B., Richards, F.M., 1971. The interpretation of protein structures: estimation of static accessibility. *J Mol Biol* 55, 379-400.

Lefranc, M.P., Duprat, E., Kaas, Q., Tranne, M., Thiriou, A., Lefranc, G., 2005. IMGT unique numbering for MHC groove G-DOMAIN and MHC superfamily (MhcSF) G-LIKE-DOMAIN. *Dev Comp Immunol* 29, 917-938.

Lilius, E.M., Marnila, P., 2001. The role of colostral antibodies in prevention of microbial infections. *Curr Opin Infect Dis* 14, 295-300.

Litman, G.W., Rast, J.P., Shambloot, M.J., Haire, R.N., Hulst, M., Roess, W., Litman, R.T., Hinds-Frey, K.R., Zilch, A., Amemiya, C.T., 1993. Phylogenetic diversification of immunoglobulin genes and the antibody repertoire. *Mol Biol Evol* 10, 60-72.

Little, M., Welschof, M., Braunagel, M., Hermes, I., Christ, C., Keller, A., Rohrbach, P., Kurschner, T., Schmidt, S., Kleist, C., Terness, P., 1999. Generation of a large complex antibody library from multiple donors. *J Immunol Methods* 231, 3-9.

Loder, F., Mutschler, B., Ray, R.J., Paige, C.J., Sideras, P., Torres, R., Lamers, M.C., Carsetti, R., 1999. B cell development in the spleen takes place in discrete steps and is determined by the quality of B cell receptor-derived signals. *J Exp Med* 190, 75-89.

Lopez, O., Perez, C., Wylie, D., 1998. A single VH family and long CDR3s are the targets for hypermutation in bovine immunoglobulin heavy chains. *Immunol Rev* 162, 55-66.

Loset, G.A., Loberli, I., Kavlie, A., Stacy, J.E., Borgen, T., Kausmally, L., Hvattum, E., Simonsen, B., Hovda, M.B., Brekke, O.H., 2005. Construction, evaluation and refinement of a large human antibody phage library based on the IgD and IgM variable gene repertoire. *J Immunol Methods* 299, 47-62.

Loset, G.A., Roux, K.H., Zhu, P., Michaelsen, T.E., Sandlie, I., 2004. Differential segmental flexibility and reach dictate the antigen binding mode of chimeric IgD and IgM: implications for the function of the B cell receptor. *J Immunol* 172, 2925-2934.

Lucier, M.R., Thompson, R.E., Waire, J., Lin, A.W., Osborne, B.A., Goldsby, R.A., 1998. Multiple sites of V lambda diversification in cattle. *J Immunol* 161, 5438-5444.

Market, E., Papavasiliou, F.N., 2003. V(D)J recombination and the evolution of the adaptive immune system. *PLoS Biol* 1, E16.

Matsumoto, H., Miyazaki, T., Rychkov, Y.G., Zhukova, O., Lebedeva, I.A., Kondik, V.M., Udina, I.G., Spitzin, V.A., Batsuur, J., Shnader, Y.V., et al., 1984. Studies on the human immunoglobulin allotypes in five populations in the USSR. *Jinrui Idengaku Zasshi* 29, 105-111.

McCormack, W.T., Thompson, C.B., 1990. Somatic diversification of the chicken immunoglobulin light-chain gene. *Adv Immunol* 48, 41-67.

McGuire, T.C., Musoke, A.J., Kurtti, T., 1979. Functional properties of bovine IgG1 and IgG2: interaction with complement, macrophages, neutrophils and skin. *Immunology* 38, 249-256.

Meffre, E., Milili, M., Blanco-Betancourt, C., Antunes, H., Nussenzweig, M.C., Schiff, C., 2001. Immunoglobulin heavy chain expression shapes the B cell receptor repertoire in human B cell development. *J Clin Invest* 108, 879-886.

Mestecky, J., 2005. *Mucosal immunology*. Elsevier Academic Press, Amsterdam; Boston.

Mestecky, J., Russell, M.W., Elson, C.O., 1999. Intestinal IgA: novel views on its function in the defence of the largest mucosal surface. *Gut* 44, 2-5.

Meyer, A., Parng, C.L., Hansal, S.A., Osborne, B.A., Goldsby, R.A., 1997. Immunoglobulin gene diversification in cattle. *Int Rev Immunol* 15, 165-183.

Montano, R.F., Morrison, S.L., 2002. Influence of the isotype of the light chain on the properties of IgG. *J Immunol* 168, 224-231.

Mossmann, H., Schmitz, B., Possart, P., Hammer, D.K., 1981. Antibody-dependent, cell-mediated cytotoxicity in cattle: transfer of IgG subclasses in relation to the protection of the newborn calf. *Adv Exp Med Biol* 137, 279-292.

Mostoslavsky, R., Singh, N., Tenzen, T., Goldmit, M., Gabay, C., Elizur, S., Qi, P., Reubinoff, B.E., Chess, A., Cedar, H., Bergman, Y., 2001. Asynchronous replication and allelic exclusion in the immune system. *Nature* 414, 221-225.

Mousavi, M., Rabbani, H., Pilstrom, L., Hammarstrom, L., 1998. Characterization of the gene for the membrane and secretory form of the IgM heavy-chain constant region gene (C $\mu$ ) of the cow (*Bos taurus*). *Immunology* 93, 581-588.

Mousavi, M., Rabbani, H., Hammarstrom, L., 1997. Characterization of the bovine epsilon gene. *Immunology* 92, 369-373.

Moutel, S., El Marjou, A., Vielemeyer, O., Nizak, C., Benaroch, P., Dubel, S., Perez, F., 2009. A multi-Fc-species system for recombinant antibody production. *BMC Biotechnol* 9, 14.

Moxley, G., Gibbs, R.S., 1992. Polymerase chain reaction-based genotyping for allotypic markers of immunoglobulin kappa shows allelic association of Km with kappa variable segment. *Genomics* 13, 104-108.

Muramatsu, M., Kinoshita, K., Fagarasan, S., Yamada, S., Shinkai, Y., Honjo, T., 2000. Class switch recombination and hypermutation require activation-induced cytidine deaminase (AID), a potential RNA editing enzyme. *Cell* 102, 553-563.

Natsume, A., In, M., Takamura, H., Nakagawa, T., Shimizu, Y., Kitajima, K., Wakitani, M., Ohta, S., Satoh, M., Shitara, K., Niwa, R., 2008. Engineered antibodies of IgG1/IgG3 mixed isotype with enhanced cytotoxic activities. *Cancer Res* 68, 3863-3872.

Nemazee, D., 2006. Receptor editing in lymphocyte development and central tolerance. *Nat Rev Immunol* 6, 728-740.

Oi, I., 1984. [Endoscopic cholangiopancreatography]. *Nihon Rinsho* 42, 2228-2230.

Padlan, E.A., Cohen, G.H., Davies, D.R., 1986. Antibody Fab assembly: the interface residues between CH1 and CL. *Mol Immunol* 23, 951-960.

Pallares, N., Lefebvre, S., Contet, V., Matsuda, F., Lefranc, M.P., 1999. The human immunoglobulin heavy variable genes. *Exp Clin Immunogenet* 16, 36-60.

Pandey, J.P., Page, G.P., Silver, R.M., LeRoy, E.C., Bona, C.A., 2001. Anti-fibrillin-1 autoantibodies in systemic sclerosis are GM and KM allotype-restricted. *Exp Clin Immunogenet* 18, 123-129.

Pandey, J.P., 2000. Immunoglobulin GM and KM allotypes and vaccine immunity. *Vaccine* 19, 613-617.

Pandey, J.P., Elson, L.H., Sutherland, S.E., Guderian, R.H., Araujo, E., Nutman, T.B., 1995. Immunoglobulin kappa chain allotypes (KM) in onchocerciasis. *J Clin Invest* 96, 2732-2734.

Pandey, J.P., Fudenberg, H.H., Virella, G., Kyong, C.U., Loadholt, C.B., Galbraith, R.M., Gotschlich, E.C., Parke, J.C., Jr., 1979. Association between immunoglobulin allotypes and immune responses to *Haemophilus influenzae* and *Meningococcus polysaccharides*. *Lancet* 1, 190-192.

Parham, N.J., Pollard, S.J., Chaudhuri, R.R., Beatson, S.A., Desvaux, M., Russell, M.A., Ruiz, J., Fivian, A., Vila, J., Henderson, I.R., 2005. Prevalence of pathogenicity island IICFT073 genes among extraintestinal clinical isolates of *Escherichia coli*. *J Clin Microbiol* 43, 2425-2434.

Parng, C.L., Hansal, S., Goldsby, R.A., Osborne, B.A., 1996. Gene conversion contributes to Ig light chain diversity in cattle. *J Immunol* 157, 5478-5486.

Parng, C.L., Hansal, S., Goldsby, R.A., Osborne, B.A., 1995. Diversification of bovine lambda-light chain genes. *Ann N Y Acad Sci* 764, 155-157.

Pasman, Y., Saini, S.S., Smith, E., Kaushik, A.K., 2010. Organization and genomic complexity of bovine lambda-light chain gene locus. *Vet Immunol Immunopathol* 135, 306-313.

Pentsuk, N., van der Laan, J.W., 2009. An interspecies comparison of placental antibody transfer: new insights into developmental toxicity testing of monoclonal antibodies. *Birth Defects Res B Dev Reprod Toxicol* 86, 328-344.



Petersen-Mahrt, S.K., Harris, R.S., Neuberger, M.S., 2002. AID mutates *E. coli* suggesting a DNA deamination mechanism for antibody diversification. *Nature* 418, 99-103.

Pilstrom, L., 2002. The mysterious immunoglobulin light chain. *Dev Comp Immunol* 26, 207-215.

Preud'homme, J.L., Petit, I., Barra, A., Morel, F., Lecron, J.C., Lelievre, E., 2000. Structural and functional properties of membrane and secreted IgD. *Mol Immunol* 37, 871-887.

Pritsch, O., Magnac, C., Dumas, G., Bouvet, J.P., Alzari, P., Dighiero, G., 2000. Can isotype switch modulate antigen-binding affinity and influence clonal selection? *Eur J Immunol* 30, 3387-3395.

Pritsch, O., Hudry-Clergeon, G., Buckle, M., Petillot, Y., Bouvet, J.P., Gagnon, J., Dighiero, G., 1996. Can immunoglobulin C(H)1 constant region domain modulate antigen binding affinity of antibodies? *J. Clin. Invest.* 98, 2235–2243.

Rabbani, H., Brown, W.R., Butler, J.E., Hammarstrom, L., 1997. Polymorphism of the IGHG3 gene in cattle. *Immunogenetics* 46, 326-331.

Ravetch, J.V., Bolland, S., 2001. IgG Fc receptors. *Annu Rev Immunol* 19, 275-290.

Ravetch, J.V., Kinet, J.P., 1991. Fc receptors. *Annu Rev Immunol* 9, 457-492.

Reynaud, C.A., Dufour, V., Weill, J.C., 1997. Generation of diversity in mammalian gut-associated lymphoid tissues: restricted V gene usage does not preclude complex V gene organization. *J Immunol* 159, 3093-3095.

Reynaud, C.A., Garcia, C., Hein, W.R., Weill, J.C., 1995. Hypermutation generating the sheep immunoglobulin repertoire is an antigen-independent process. *Cell* 80, 115-125.

Reynaud, C.A., Mackay, C.R., Muller, R.G., Weill, J.C., 1991. Somatic generation of diversity in a mammalian primary lymphoid organ: the sheep ileal Peyer's patches. *Cell* 64, 995-1005.

Rhoades, R., 2002. *Human physiology*. Thomson Learning, Philadelphia, PA.  
Rogers, K.A., Richardson, J.P., Scinicariello, F., Attanasio, R., 2006. Molecular characterization of immunoglobulin D in mammals: immunoglobulin heavy constant delta genes in dogs, chimpanzees and four old world monkey species. *Immunology* 118, 88-100.

Rowe, E.S., 1976. Dissociation and denaturation equilibria and kinetics of a homogeneous human immunoglobulin Fab fragment. *Biochemistry* 15, 905-916.

Saini, S.S., Farrugia, W., Muthusamy, N., Ramsland, P.A., Kaushik, A.K., 2007. Structural evidence for a new IgG1 antibody sequence allele of cattle. *Scand J Immunol* 65, 32-38.

Saini, S.S., Farrugia, W., Ramsland, P.A., Kaushik, A.K., 2003. Bovine IgM antibodies with exceptionally long complementarity-determining region 3 of the heavy chain share unique structural properties conferring restricted VH + Vlambda pairings. *Int Immunol* 15, 845-853.

Saini, S.S., Kaushik, A., 2002. Extensive CDR3H length heterogeneity exists in bovine foetal VDJ rearrangements. *Scand J Immunol* 55, 140-148.

Saini, S.S., Kaushik, A., 2001. Origin of bovine IgM structural variants. *Mol Immunol* 38, 389-396.

Saini, S.S., Allore, B., Jacobs, R.M., Kaushik, A., 1999. Exceptionally long CDR3H region with multiple cysteine residues in functional bovine IgM antibodies. *Eur J Immunol* 29, 2420-2426.

Saini, S.S., Hein, W.R., Kaushik, A., 1997. A single predominantly expressed polymorphic immunoglobulin VH gene family, related to mammalian group, I, clan, II, is identified in cattle. *Mol Immunol* 34, 641-651.

Sauer-Eriksson, A.E., Kleywegt, G.J., Uhlen, M., Jones, T.A., 1995. Crystal structure of the C2 fragment of streptococcal protein G in complex with the Fc domain of human IgG. *Structure* 3, 265-278.

Schanfield, M.S., Ferrell, R.E., Hossaini, A.A., Gerald Sandler, S., Stevenson, J.C., 2008. Immunoglobulin allotypes in Southwest Asia: populations at the crossroads. *Am J Hum Biol* 20, 671-682.

Shojaei, F., Saini, S.S., Kaushik, A.K., 2003. Unusually long germline DH genes contribute to large sized CDR3H in bovine antibodies. *Mol Immunol* 40, 61-67.

Simianer, H., Kohn, F., 2010. Genetic management of the Gottingen Minipig population. *J Pharmacol Toxicol Methods* 62, 221-226.

Sinclair, M.C., Gilchrist, J., Aitken, R., 1997. Bovine IgG repertoire is dominated by a single diversified VH gene family. *J Immunol* 159, 3883-3889.

Sinclair, M.C., Gilchrist, J., Aitken, R., 1995. Molecular characterization of bovine V lambda regions. *J Immunol* 155, 3068-3078.

Singh, U., Verma, P.K., Bhagat, P., Singh, S., Singh, N.K., 2011. IgG RF and anti-CCP2 antibody can be positive in undifferentiated arthritis due to streptococcal infection, hepatitis B virus, tuberculosis, trauma and hypothyroidism: a preliminary study. *Rheumatol Int.*

Song, X.M., Perez-Casal, J., Fontaine, M.C., Potter, A.A., 2002. Bovine immunoglobulin A (IgA)-binding activities of the surface-expressed Mig protein of *Streptococcus dysgalactiae*. *Microbiology* 148, 2055-2064.

Strausbach PH, H.E., Givol D, 1971. Interchain disulfide bonds of goat immunoglobulin G. *Biochemistry* 10, 2231–2237.

Sun, J., Kacs Kovics, I., Brown, W.R., Butler, J.E., 1994. Expressed swine VH genes belong to a small VH gene family homologous to human VHIII. *J Immunol* 153, 5618-5627.

Sun, Y., Wang, C., Wang, Y., Zhang, T., Ren, L., Hu, X., Zhang, R., Meng, Q., Guo, Y., Fei, J., Li, N., Zhao, Y., 2010. A comprehensive analysis of germline and expressed immunoglobulin repertoire in the horse. *Dev Comp Immunol* 34, 1009-1020.

Symons, D.B., Clarkson, C.A., Beale, D., 1989. Structure of bovine immunoglobulin constant region heavy chain gamma 1 and gamma 2 genes. *Mol Immunol* 26, 841-850.

Symons, D.B., Clarkson, C.A., Milstein, C.P., Brown, N.R., Beale, D., 1987. DNA sequence analysis of two bovine immunoglobulin CH gamma pseudogenes. *J Immunogenet* 14, 273-283.

Tao, M.H., Canfield, S.M., Morrison, S.L., 1991. The differential ability of human IgG1 and IgG4 to activate complement is determined by the COOH-terminal sequence of the CH2 domain. *J Exp Med* 173, 1025-1028.

Taussig, M.J., Stoevesandt, O., Borrebaeck, C.A., Bradbury, A.R., Cahill, D., Cambillau, C., de Daruvar, A., Dubel, S., Eichler, J., Frank, R., Gibson, T.J., Gloriam, D., Gold, L., Herberg, F.W., Hermjakob, H., Hoheisel, J.D., Joos, T.O., Kallioniemi, O., Koegl, M., Konthur, Z., Korn, B., Kremmer, E., Krobitsch, S., Landegren, U., van der Maarel, S., McCafferty, J., Muyldermans, S., Nygren, P.A., Palcy, S., Pluckthun, A., Polic, B., Przybylski, M., Saviranta, P., Sawyer, A., Sherman, D.J., Skerra, A., Templin, M., Ueffing, M., Uhlen, M., 2007. ProteomeBinders: planning a European resource of affinity reagents for analysis of the human proteome. *Nat Methods* 4, 13-17.

Thompson, J.D., Higgins, D.G., Gibson, T.J., 1994. CLUSTAL W: improving the sensitivity of progressive multiple sequence alignment through sequence weighting, position-specific gap penalties and weight matrix choice. *Nucleic Acids Res* 22, 4673-4680.

Tobin-Janzen, T.C., Womack, J.E., 1992. Comparative mapping of IGHG1, IGHM, FES, and FOS in domestic cattle. *Immunogenetics* 36, 157-165.

Tomlinson, I.M., Walter, G., Jones, P.T., Dear, P.H., Sonnhammer, E.L., Winter, G., 1996. The imprint of somatic hypermutation on the repertoire of human germline V genes. *J Mol Biol* 256, 813-817.

Torres, M., Fernandez-Fuentes, N., Fiser, A., Casadevall, A., 2007. The immunoglobulin heavy chain constant region affects kinetic and thermodynamic parameters of antibody variable region interactions with antigen. *J Biol Chem* 282, 13917-13927.

Van Oss, C.J., Van Regenmortel, M.H.V., 1994. *Immunochemistry*. M. Dekker, New York.

Wagner, B., Miller, D.C., Lear, T.L., Antczak, D.F., 2004. The complete map of the Ig heavy chain constant gene region reveals evidence for seven IgG isotypes and for IgD in the horse. *J Immunol* 173, 3230-3242.

Watson, D.L., 1976. The effect of cytophilic IgG2 on phagocytosis by ovine polymorphonuclear leucocytes. *Immunology* 31, 159-165.

Weichhold, G.M., Ohnheiser, R., Zachau, H.G., 1993. The human immunoglobulin kappa locus consists of two copies that are organized in opposite polarity. *Genomics* 16, 503-511.

Weiner, C., Pan, Q., Hurtig, M., Boren, T., Bostwick, E., Hammarstrom, L., 1999. Passive immunity against human pathogens using bovine antibodies. *Clin Exp Immunol* 116, 193-205.

Weinstein, P.D., Anderson, A.O., Mage, R.G., 1994. Rabbit IgH sequences in appendix germinal centers: VH diversification by gene conversion-like and hypermutation mechanisms. *Immunity* 1, 647-659.

Woof, J.M., Burton, D.R., 2004. Human antibody-Fc receptor interactions illuminated by crystal structures. *Nat Rev Immunol* 4, 89-99.

Yoo, E.M., Chintalacharuvu, K.R., Penichet, M.L., Morrison, S.L., 2002. Myeloma expression systems. *J Immunol Methods* 261, 1-20.

Zachau, H.G., 1993. The immunoglobulin kappa locus-or-what has been learned from looking closely at one-tenth of a percent of the human genome. *Gene* 135, 167-173.

Zhao, Y., Jackson, S.M., Aitken, R., 2006. The bovine antibody repertoire. *Dev Comp Immunol* 30, 175-186.

Zhao, Y., Kacs Kovics, I., Rabbani, H., Hammarstrom, L., 2003. Physical mapping of the bovine immunoglobulin heavy chain constant region gene locus. *J Biol Chem* 278, 35024-35032.

Zhao, Y., Kacs Kovics, I., Pan, Q., Liberles, D.A., Geli, J., Davis, S.K., Rabbani, H., Hammarstrom, L., 2002. Artiodactyl IgD: the missing link. *J Immunol* 169, 4408-4416.

Zimin, A.V., Delcher, A.L., Florea, L., Kelley, D.R., Schatz, M.C., Puiu, D., Hanrahan, F., Pertea, G., Van Tassell, C.P., Sonstegard, T.S., Marcais, G., Roberts, M., Subramanian, P., Yorke, J.A., Salzberg, S.L., 2009. A whole-genome assembly of the domestic cow, *Bos taurus*. *Genome Biol* 10, R42.

---

<http://www.abcam.com/index.html?pageconfig=resource&rid=11258&pid=11287>

Visited at 28.11.2011.





## 9 List of publications

Diesterbeck, U.S., Aboelhassan, D.M., Stein, S.K., Czerny, C.P., 2011. Detection of new allotypic variants of bovine  $\lambda$ -light chain constant regions in different cattle breeds. *Developmental & Comparative Immunology* 36, 130–139.

Mahrous, K.F., Ramadan, H.A.I., Abdel-Aziem, S.H., Abd-El Mordy, M., Aboelhassan, D.M., 2011. Genetic variations between camel breeds using microsatellite markers and RAPD techniques. *Applied Biosciences* 39, 2626–2634.

Stein, S.K., Diesterbeck, U.S., Aboelhassan, D.M., Czerny, C.P., 2011. Organization of the bovine Ig  $\kappa$  locus and comparison of constant  $\kappa$ -light chain regions in different cattle breeds. *Animal Genetics*. In Press.

### Presentation

Aboelhassan, D.M., Stein, S.K., Diesterbeck, U.S., Czerny, C.P. 2009. Transcriptional analyses of IgG heavy- and light chains in different cattle breeds. Vortragstagung der DGfZ und GfT 2009, Gießen, Germany, 16.-17.09.2009. Conference Book.

Walther, S., Diesterbeck, U.S., Aboelhassan, D.M., Stein S.K., König, S., Czerny, C.P., 2011. Transcriptional analysis of equine  $\lambda$ -light chains, detection and comparison of new allotypic variants of equine and bovine  $\lambda$ -light chain constant regions, Anbei die Dateien für Abstract und Poster für das Horizons Symposium in Göttingen, Germany.

## 10 Acknowledgments

First of all I am greatly indebted for my work and success to our Merciful “Allah” Who gave me the ability to finish this work.

Great appreciation, profound gratitude and deepest thanks to **Prof. Dr. Dr. Claus-Peter Czerny** for his kind supervision, valuable advices, encouragement, and pertinent suggestions during the course of this study as well as for the revision that enabled me to finish this work. I am indebted to him more than he knows.

I would like to express my gratitude to **Dr. Ulrike Diesterbeck**, for teaching me the methodological techniques that enabled me to achieve this work, science discussion and the pleasure of working with her in this field. I am grateful in every possible way and hope to keep up our collaboration in the future.

Grateful thanks are also extended to all members of the **Division of Microbiology and Animal Hygiene**, Department of Animal Sciences, Faculty of Agricultural Sciences, Georg-August University Goettingen and friends for their help and encouragement.

I convey a special acknowledgement to **Prof. Dr. Karima Mahrous and Dr. Wagdy Khalil Basaly**. Cell Biology Department, Molecular Genetics and Biotechnology Division, National Research Center, Giza, Egypt for their indispensable help without their support, I would not be in Germany.

I would like to thank the **Egyptian Ministry of Higher Education** for supporting me in earning my PhD from Germany.

Words fail me in expressing my appreciation to my parents and husband, **Hesham**, whose dedication, love and persistent confidence in me, have taken a load off my shoulders. And many thanks for my sweet daughters **Genesia and Rona** who listen to me and let me to concentrate at my work. My brothers **Sherif** and **Mahmoud**, my sister **Hend** and her husband **Ayman** deserve special mention for their constant support and prayers.

## 11 Curriculum Vitae

### Personal details

Name Dalia Mohamed Hemdan Aboelhassan

Sex Female

Date of birth 30 Oktober 1976

Place of birth Cairo, Egypt

Nationality Egyptian

Marital status Married, two daughters (born in 2006, and 2011)

Address Private: 32 Rawash Street, Elnour City, Elmataria  
Cairo, Egypt

Office: Cell Biology Department  
Molecular Genetics and Biotechnology Division  
National Research Center  
Giza, Egypt

### Education

1981 - 1987 Elementary school, Cairo, Egypt

1987 - 1991 Secondary school, Cairo, Egypt

1991 - 1994 High school, Cairo, Egypt

1994 - 1999 Bachelor of Science, Biology Department  
Faculty of Science, Ain Shams University  
Cairo, Egypt

2002 - 2005 Master degree of Molecular Genetics, Faculty of Science, Ain  
Shams University, Cairo, Egypt

2007 - Present PhD student in Division of Microbiology and Animal  
Hygiene,  
Department of Animal Sciences, Faculty of Agriculture  
Sciences  
Georg- August- University, Goettingen, Germany

### Professional experience

- 
- 2000- 2001      Assistant lecturer in the Faculty of Science, Ain Shams  
University, Cairo, Egypt
- 2001- 2005      Assistant reasercher in National Research Center  
Giza, Egypt
- 2005 – Present      Reasercher assistant in National Research Center  
Giza, Egypt

---